

<b>STUDENT NAME</b>	<b>MARK</b>
	...../58 .....%
<b>TEACHER CODE:</b>	

## PHYSICS

### SAC 1: How do things move without contact?

**Reading time: 5 minutes**

**Writing time: 55 minutes**

#### QUESTION AND ANSWER BOOK

<i>Section</i>	<i>Number of questions</i>	<i>Number of marks</i>
Part A - Multiple choice	14	28
Part B - Short answer	7	30
<b>Total</b>	<b>21</b>	<b>58</b>

- Students are permitted to bring into the examination room: one single sided A4 sheet of notes, pens, pencils, highlighters, erasers, sharpeners, rulers, and one scientific calculator.
- Students are NOT permitted to bring into the examination room: blank sheets of paper, white out liquid/tape or a CAS calculator.

#### Materials supplied

- Question and answer book, MC answer sheet and a formula sheet.

#### Instructions

- Write your **name** in the space provided above on this page.
- Unless otherwise indicated, the diagrams in this paper are **not** drawn to scale.
- All written responses must be in English and in **blue or black pen**. Diagrams and graphs may be drawn in pencil.

**Students are NOT permitted to bring mobile phones and/or any other unauthorised electronic devices (watches) into the test room.**



### Fields and application of field concepts

electric field between charged plates	$E = \frac{V}{d}$
energy transformations of charges in an electric field	$\frac{1}{2}mv^2 = qV$
field of a point charge	$E = \frac{kq}{r^2}$
force on an electric charge	$F = qE$
Coulomb's law	$F = \frac{kq_1q_2}{r^2}$
magnetic force on a moving charge	$F = qvB$
magnetic force on a current	$F = IlB$
radius of a charged particle in a magnetic field	$r = \frac{mv}{qB}$
gravitational potential energy near the surface of Earth	$mg\Delta h$
kinetic energy	$\frac{1}{2}mv^2$
Newton's law of universal gravitation	$F = G \frac{M_1M_2}{r^2}$
gravitational field	$g = G \frac{M}{r^2}$

### Prefixes/Units

p = pico = $10^{-12}$	n = nano = $10^{-9}$	$\mu$ = micro = $10^{-6}$	m = milli = $10^{-3}$
k = kilo = $10^3$	M = mega = $10^6$	G = giga = $10^9$	t = tonne = $10^3$ kg

$$k = 9.0 \times 10^9 Nm^2C^{-2}$$

<b>STUDENT NAME</b>
<b>TEACHER CODE: GAVA GRAK MAYR MOHZ</b>

## PHYSICS

SAC 1: How do things move without contact?

MULTIPLE CHOICE ANSWER SHEET

Question	Colour in or circle the box with the best answer (one per question)				
1	a	b	c	d	e
2	a	b	c	d	e
3	a	b	c	d	e
4	a	b	c	d	e
5	a	b	c	d	e
6	a	b	c	d	e
7	a	b	c	d	e
8	a	b	c	d	e
9	a	b	c	d	e
10	a	b	c	d	e
11	a	b	c	d	e
12	a	b	c	d	e
13	a	b	c	d	e
14	a	b	c	d	e



## Part A: Multiple choice answers (2 marks each = 28 marks)

Please circle the correct answer on the multiple choice answer sheet provided with this booklet.

1. A  $-4.0 \mu\text{C}$  charge is located  $0.45 \text{ m}$  to the left of a  $+6.0 \mu\text{C}$  charge. What is the magnitude and direction of the electrostatic force on the positive charge?  
( $k = 9.0 \times 10^9 \text{ Nm}^2\text{C}^{-2}$ )
  - A)  $2.2 \text{ N}$ , to the right
  - B)  $2.2 \text{ N}$ , to the left
  - C)  $1.1 \text{ N}$ , to the right
  - D)  $1.1 \text{ N}$ , to the left
  - E)  $4.4 \text{ N}$ , to the right
2. Determine the ratio of the electrostatic force to the gravitational force between a proton and an electron,  $F_E/F_G$ . **Note:**  $k = 9.00 \times 10^9 \text{ Nm}^2\text{C}^{-2}$ ;  $G = 6.67 \times 10^{-11} \text{ Nm}^2\text{kg}^{-2}$ ;  $m_e = 9.109 \times 10^{-31} \text{ kg}$ ; and  $m_p = 1.672 \times 10^{-27} \text{ kg}$ .
  - A)  $1.24 \times 10^{23}$
  - B)  $2.52 \times 10^{29}$
  - C)  $1.15 \times 10^{31}$
  - D)  $2.26 \times 10^{39}$
  - E)  $1.42 \times 10^{58}$
3. An electron traveling horizontally enters a region where a uniform electric field is directed upward. What is the direction of the force exerted on the electron once it has entered the field?

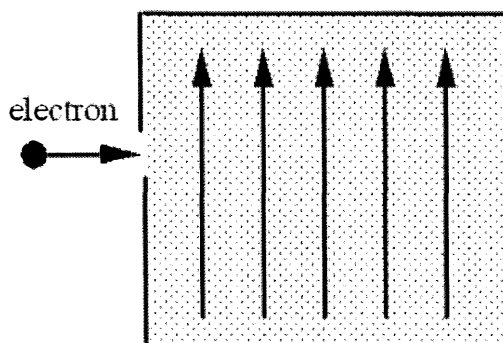

- A) to the left
- B) to the right
- C) upward
- D) downward
- E) out of the page, toward the reader

4. Which one of the following statements is true concerning the strength of the electric field between two oppositely charged parallel plates?
- A) It is zero midway between the plates.
  - B) It is a maximum midway between the plates.
  - C) It is a maximum near the positively charged plate.
  - D) It is a maximum near the negatively charged plate.
  - E) It is constant between the plates except near the edges.

5. A helium nucleus is located between the plates of a parallel-plate capacitor as shown. The nucleus has a charge of  $+2e$  and a mass of  $6.6 \times 10^{-27}$  kg. What is the magnitude of the electric field such that the electric force exactly balances the weight of the helium nucleus so that it remains stationary?

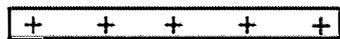
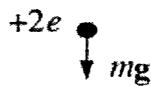

- A)  $4.0 \times 10^{-7}$  N/C
  - B)  $6.6 \times 10^{-26}$  N/C
  - C)  $2.0 \times 10^{-7}$  N/C
  - D)  $5.0 \times 10^{-3}$  N/C
  - E)  $1.4 \times 10^{-8}$  N/C
6. A charge  $q = -6.0 \mu\text{C}$  is moved  $0.25$  m horizontally to point **P** in a region where an electric field is  $250$  V/m directed vertically, as shown. What is the change in the electric potential energy of the charge?

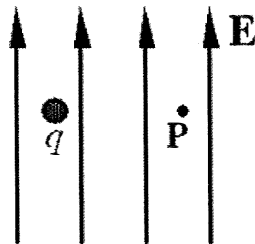

- A)  $-2.4 \times 10^{-5}$  J
- B)  $-1.5 \times 10^{-4}$  J
- C) 0 J
- D)  $+1.5 \times 10^{-4}$  J
- E)  $+2.4 \times 10^{-5}$  J

Use the following to answer questions 7-8:

**P** and **Q** are points within a uniform electric field that are separated by a distance of 0.2 m as shown. The potential difference (voltage) between **P** and **Q** is 75 V.

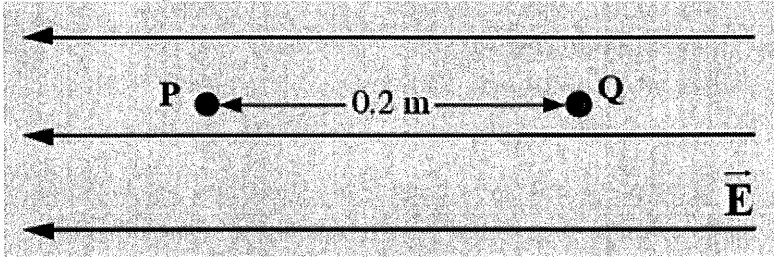

7. Determine the magnitude of this electric field.
- A) 15 V/m
  - B) 75 V/m
  - C) 375 V/m
  - D) 750 V/m
  - E) 1100 V/m
8. How much work is required to move a  $+150 \mu\text{C}$  point charge from **P** to **Q**?
- A) 0.023 J
  - B) 0.011 J
  - C) 75 J
  - D) 140 J
  - E) 2800 J
9. A charged particle is moving in a uniform, constant magnetic field. Which one of the following statements concerning the magnetic force exerted on the particle is **false**?
- A) The magnetic force does no work on the particle.
  - B) The magnetic force increases the speed of the particle.
  - C) The magnetic force changes the velocity of the particle.
  - D) The magnetic force can act only on a particle in motion.
  - E) The magnetic force does not change the kinetic energy of the particle.



10. A proton traveling due east in a region that contains only a magnetic field experiences a vertically *upward force* (away from the surface of the earth). What is the direction of the magnetic field?

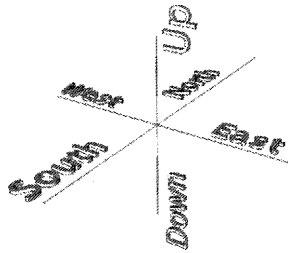

- A) north  
 B) east  
 C) south  
 D) west  
 E) down
11. An electron traveling horizontally enters a region where a uniform magnetic field is directed into the plane of the paper as shown. Which one of the following phrases most accurately describes the motion of the electron once it has entered the field?

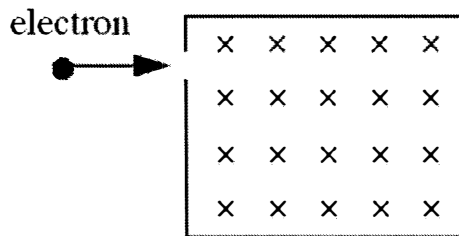

- A) upward and parabolic  
 B) upward and circular  
 C) downward and circular  
 D) upward, along a straight line  
 E) downward and parabolic

12. A coil of wire carries current  $I$  as shown in the figure. If the observer could “see” the magnetic field inside this arrangement of loops, how would it appear?

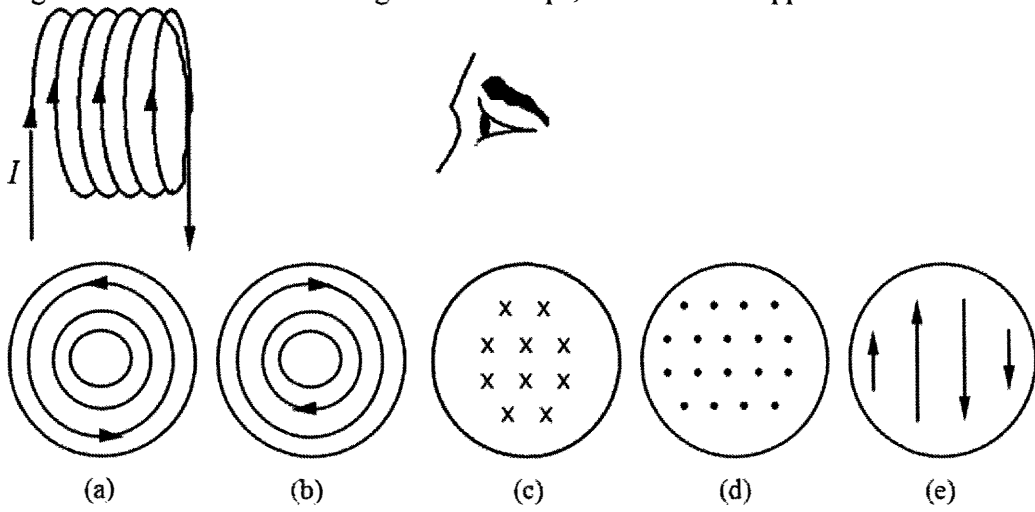

- A) a
- B) b
- C) c
- D) d
- E) e

The following information regards questions 13-14:

A car is on top of a hill at X,  $h$  metres above the top of a cliff. The top of the cliff is  $H$  metres above the water level. The brakes are released and the car begins to roll back down the hill. When the car reaches the cliff at Y it is projected horizontally and travels a horizontal distance,  $d$  metres, from the cliff edge. It enters the water at Z. Take the acceleration due to gravity as  $g$  downwards. (For the following questions, ignore air resistance.)

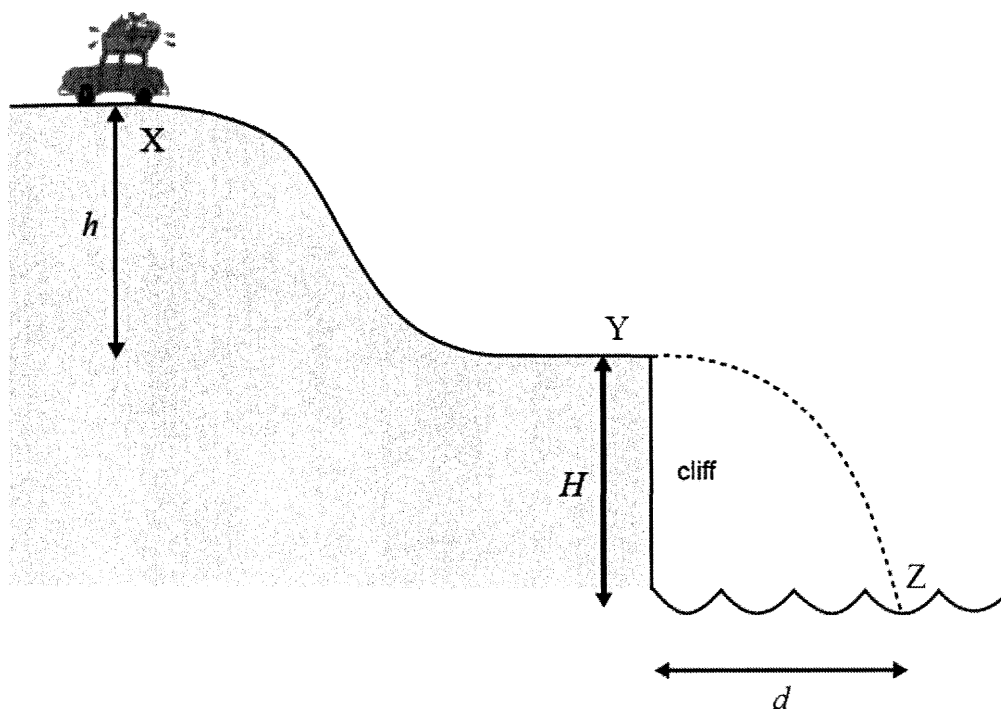

13. Which of the expressions (A.–D.) gives the speed of the car at point Y?

- A)  $\sqrt{2gh}$
- B)  $\sqrt{2gH}$
- C)  $\sqrt{2g(h + H)}$
- D)  $\sqrt{2g(h - H)}$
- E)  $\sqrt{2g(H - h)}$

14. Which of the following expressions (A.–D.) is the actual speed of the car just before hitting the water at point Z?

A)  $\sqrt{2gh}$

B)  $\sqrt{2gH}$

C)  $\sqrt{2g(h + H)}$

D)  $\sqrt{2g(h - H)}$

E)  $\sqrt{2g(H - h)}$

**END MULTIPLE CHOICE SECTION A**

## Part B: Short Answer Questions (32 marks)

### Question 1 (4 marks)

The Mars Odyssey spacecraft was launched from Earth on 7 April 2001 and arrived at Mars on 23 October 2001. The figure below is a graph of the gravitational force acting on the 700 kg Mars Odyssey spacecraft plotted against height above Earth's surface.

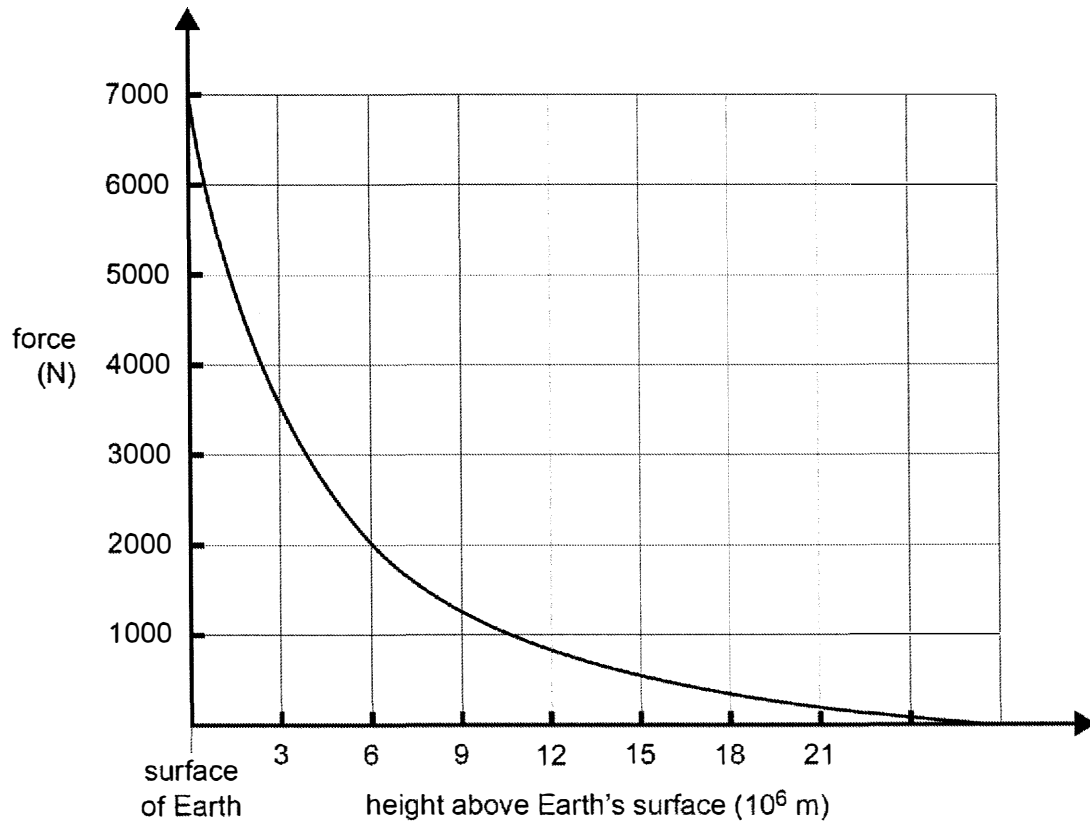

Estimate the launch energy needed for Mars Odyssey to escape Earth's gravitational attraction (to reach a point where the gravitational field strength of the Earth is negligible) and to reach a velocity of 17 km/s.

Question 2 (3 marks)

A space capsule is returning to Earth from interplanetary space. Using its rocket motor to control its direction, it is moving at **constant speed** along a **straight line XY** some distance from the Earth. At point P the gravitational field strength due to the Earth is  $1.5 \text{ ms}^{-2}$ . What is the size of the normal reaction force on a 100 kg person in the situation shown in the diagram?

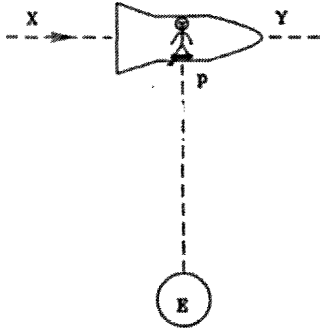

Question 3 (3 marks)

Quaoar is a very large asteroid orbiting the Sun in a circular orbit beyond Pluto. The distance between Quaoar and the Sun is  $6.5 \times 10^{12} \text{ m}$ . ( $G = 6.67 \times 10^{-11} \frac{\text{Nm}^2}{\text{kg}^2}$ ,  $M_{\text{Sun}} = 2.0 \times 10^{30} \text{ kg}$ ) Calculate the speed of Quaoar in its orbit around the Sun.

Question 4 (4 marks)

A beam consisting of five types of ions labeled **A**, **B**, **C**, **D**, and **E** enters a region that contains a uniform magnetic field as shown in the figure below. The field is perpendicular to the plane of the paper, but its precise direction is not given. All ions in the beam travel with the same speed. The table below gives the masses and charges of the ions. **Note:** 1 mass unit =  $1.67 \times 10^{-27}$  kg and  $e = 1.6 \times 10^{-19}$  C

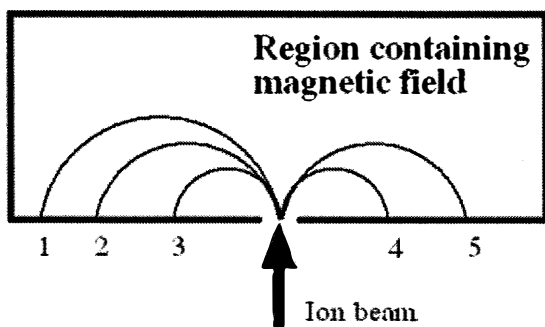

<u>Ion</u>	<u>Mass</u>	<u>Charge</u>
<b>A</b>	2 units	+ $e$
<b>B</b>	4 units	+ $e$
<b>C</b>	6 units	+ $e$
<b>D</b>	2 units	- $e$
<b>E</b>	4 units	- $e$

- a. Which ion falls at position 2? Justify your answer.

2 marks

- b. What is the direction of the magnetic field? Justify.

2 marks

- c. Determine the magnitude of the magnetic field if ion A travels in a semicircular path of radius 0.50 m at a speed of  $5.0 \times 10^6$  m/s.

2 marks

Question 5 (6 marks)

A particle with a mass of  $6.64 \times 10^{-27}$  kg and a charge of  $+3.20 \times 10^{-19}$  C is accelerated from rest through a potential difference of  $9 \times 10^4$  V. The particle then enters a uniform 1.60 mT magnetic field. If the particle's velocity is perpendicular to the magnetic field at all times, what is the magnitude of the magnetic force exerted on the particle?

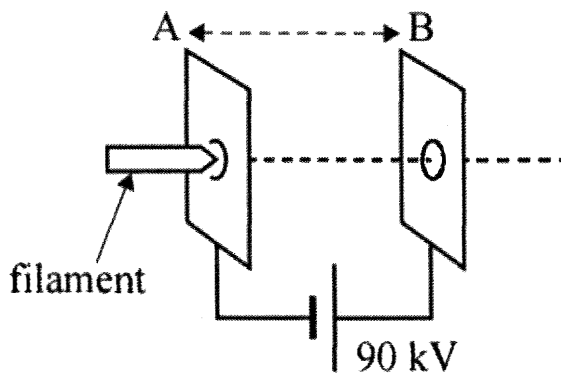

- a. What is the kinetic energy acquired by the unknown particle as it is accelerated in the electric field?

2 marks



b. What is the speed of the particle as it passes point B?

2 marks

c. If the particle's velocity is perpendicular to the magnetic field at all times, what is the magnitude of the magnetic force exerted on the particle?

2 marks

Question 6 (3 marks)

The figure below shows a power line at a mining site that carries a DC current of 1000 A running from west to east. The Earth's magnetic field at the mining site is  $5.0 \cdot 10^{-5} \text{T}$ , running horizontally from south to north.

An engineer is concerned about the electromagnetic force due to the Earth's magnetic field on the wire between the two support poles, which are 30 m apart.

Calculate the magnitude and direction (north, south, east, west, up, down) of the force due to the earth's magnetic field on the 30 m section of wire between the two poles.

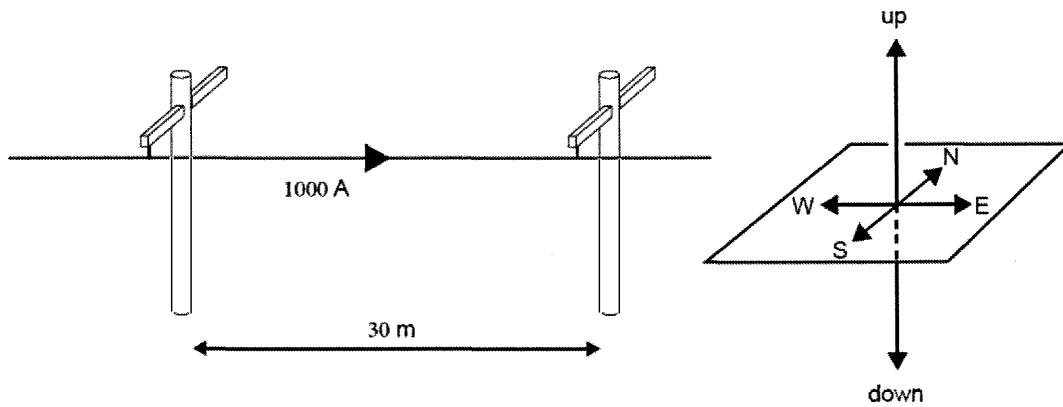

Question 7 (7 marks)

The figure below shows a schematic diagram of a DC motor. The coil JKLM is 20 cm (JK) by 10 cm (KL) and has 500 turns. The strength of the magnetic field passing through the coil is 100 mT. The DC power supply generates a current of 2.0 A.

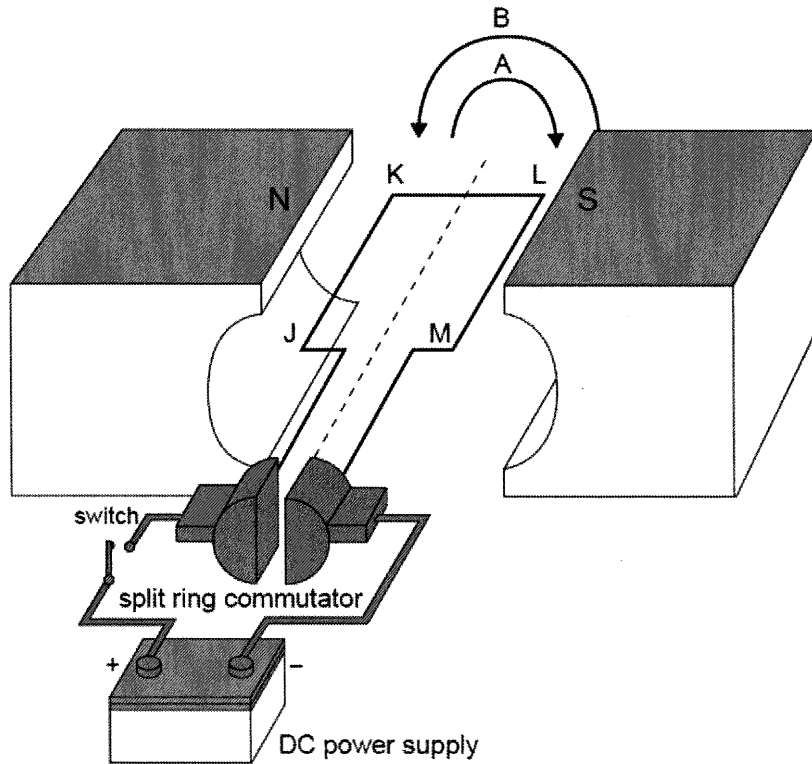

- a. In which direction, A (clockwise) or B (anticlockwise), will the motor rotate when the switch is closed?

1 mark

b. What is the magnitude and direction of the magnetic force acting on side LM?

2 marks

c. What is the magnitude and direction of the magnetic force acting on side KL?

1 mark

d. Explain the role of the split ring commutator in the good functioning of the motor?

3 marks

**SECTION B****Question 1** (2 marks)

Two bar magnets are placed close to each other, as shown in Figure 1.

Sketch the shape and the direction of **at least four** magnetic field lines between the two poles within the dashed border shown in Figure 1.

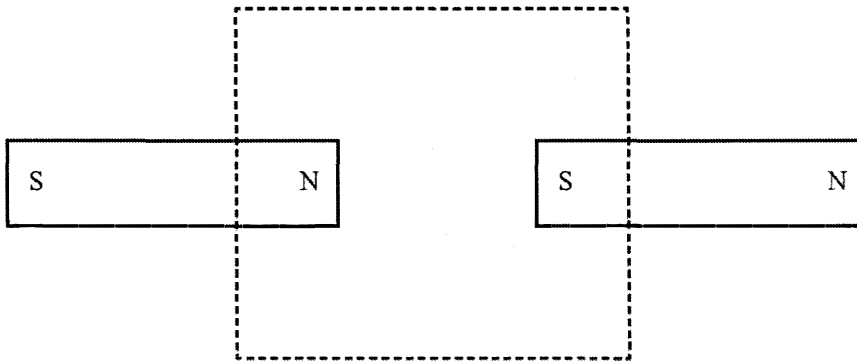

**Figure 1**

**SECTION B – continued**

**Question 2 (3 marks)**

Gravitation, magnetism and electricity can be explained using a field model. According to our understanding of physics and current experimental evidence, these three field types can be associated with only monopoles, only dipoles or both monopoles and dipoles.

In the table below, indicate whether each field type can be associated with only monopoles, only dipoles or both monopoles and dipoles by ticking (✓) the appropriate box.

<b>Field type</b>	<b>Only monopoles</b>	<b>Only dipoles</b>	<b>Both monopoles and dipoles</b>
gravitation			
magnetism			
electricity			

**SECTION B – continued**  
**TURN OVER**

**Question 3** (6 marks)

Electron microscopes use a high-precision electron velocity selector consisting of an electric field,  $E$ , perpendicular to a magnetic field,  $B$ .

Electrons travelling at the required velocity,  $v_0$ , exit the aperture at point Y, while electrons travelling slower or faster than the required velocity,  $v_0$ , hit the aperture plate, as shown in Figure 2.

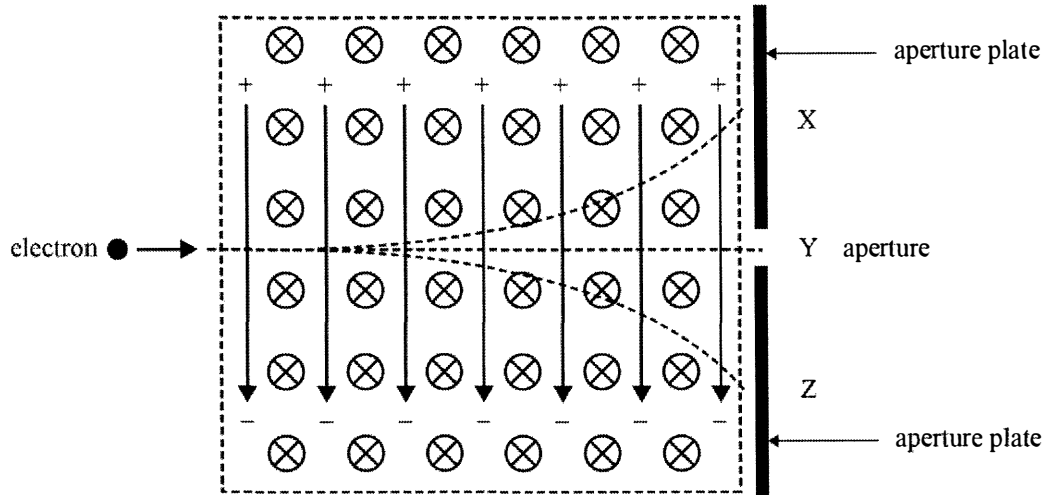
**Figure 2**

- a. Show that the velocity of an electron that travels straight through the aperture to point Y is given by

$$v_0 = \frac{E}{B}$$

1 mark

---



---

- b. Calculate the magnitude of the velocity,  $v_0$ , of an electron that travels straight through the aperture to point Y if  $E = 500 \text{ kV m}^{-1}$  and  $B = 0.25 \text{ T}$ . Show your working.

2 marks

---



---



---

$\text{m s}^{-1}$
-------------------

SECTION B – Question 3 – continued

- c. i. At which of the points – X, Y or Z – in Figure 2 could electrons travelling faster than  $v_0$  arrive? 1 mark

- ii. Explain your answer to **part c.i.** 2 marks

---

---

---

---

---

SECTION B – continued  
TURN OVER



**Question 4** (10 marks)

The Ionospheric Connection Explorer (ICON) space weather satellite, constructed to study Earth's ionosphere, was launched in October 2019. ICON will study the link between space weather and Earth's weather at its orbital altitude of 600 km above Earth's surface. Assume that ICON's orbit is a circular orbit. Use  $R_E = 6.37 \times 10^6$  m.

- a. Calculate the orbital radius of the ICON satellite.

1 mark

---

m
---

- b. Calculate the orbital period of the ICON satellite correct to three significant figures. Show your working.

4 marks

---

---

---

---

---

---

---

---

---

s
---

- c. Explain how the ICON satellite maintains a stable circular orbit without the use of propulsion engines. . 2 marks

---

---

---

---

SECTION B – Question 4 – continued

- d. Figure 3 shows the strength of Earth's gravitational field,  $g$ , as a function of orbital altitude,  $h$ , above the surface of Earth.

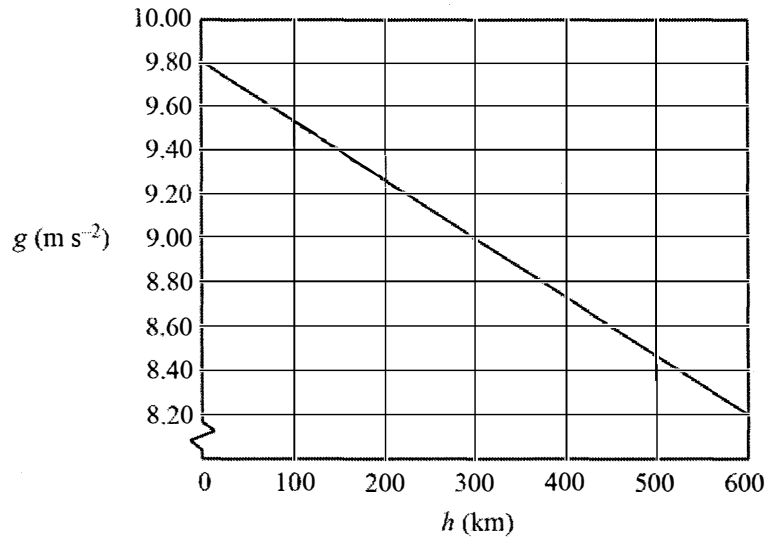

**Figure 3**

Determine the change in gravitational potential energy of the ICON satellite as it travels from Earth's surface to its orbital altitude of 600 km above Earth's surface. The mass of the ICON satellite is 288 kg.

3 marks

---



---



---



---



---

J
---

**SECTION B – continued**  
**TURN OVER**

## Velocity Selector

In many experiments involving moving charged particles, it is important that the particles all move with essentially the same velocity. This can be achieved by applying a combination of an electric field and a magnetic field oriented as shown in Figure.

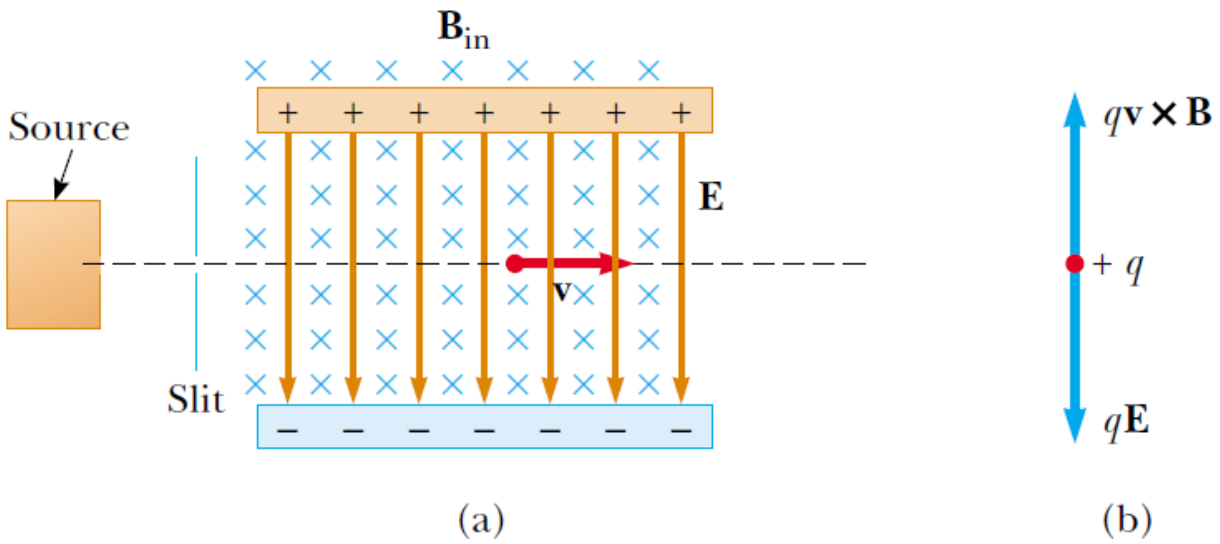

When the magnitudes of the two fields are chosen so that  $qE = qvB$ , the particle moves in a straight horizontal line through the region of the fields. From the expression  $qE = qvB$ , we find that

$$v = \frac{E}{B}$$

Only those particles having speed  $v$  pass undeflected through the mutually perpendicular electric and magnetic fields. The magnetic force exerted on particles moving at speeds greater than this is stronger than the electric force, and the particles are deflected upward. Those moving at speeds less than this are deflected downward.

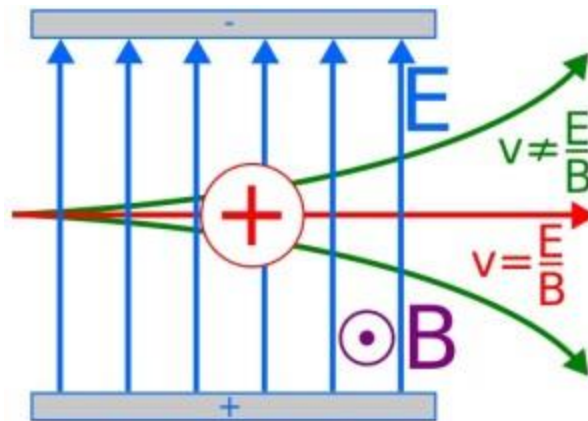

2020 VCAA

**Question 3 (6 marks)**

Electron microscopes use a high-precision electron velocity selector consisting of an electric field,  $E$ , perpendicular to a magnetic field,  $B$ .

Electrons travelling at the required velocity,  $v_0$ , exit the aperture at point Y, while electrons travelling slower or faster than the required velocity,  $v_0$ , hit the aperture plate, as shown in Figure 2.

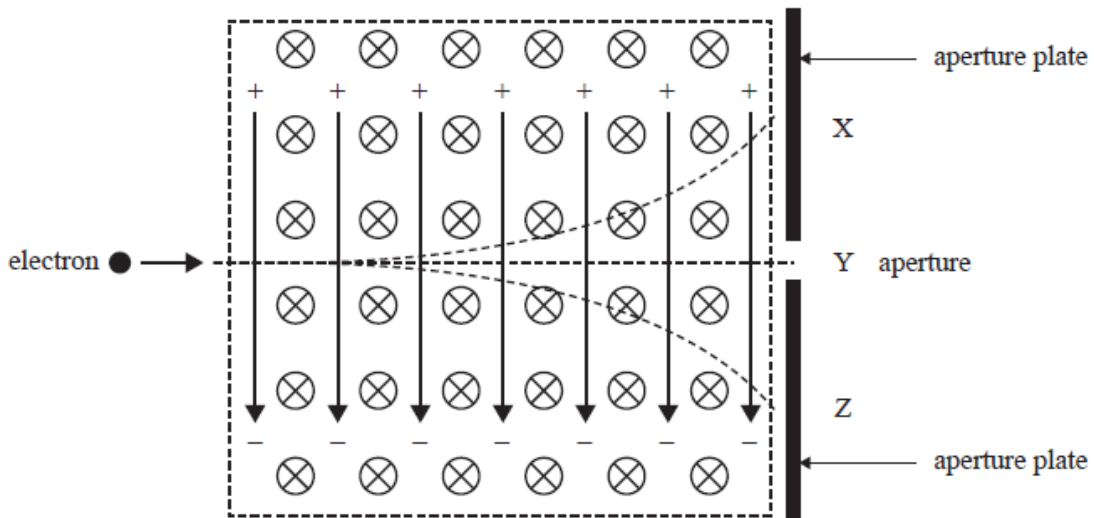

Figure 2

- a. Show that the velocity of an electron that travels straight through the aperture to point Y is given by

$$v_0 = \frac{E}{B}$$

1 mark

---



---

- b. Calculate the magnitude of the velocity,  $v_0$ , of an electron that travels straight through the aperture to point Y if  $E = 500 \text{ kV m}^{-1}$  and  $B = 0.25 \text{ T}$ . Show your working. 2 marks

---



---



---

$\text{m s}^{-1}$

- c. i. At which of the points – X, Y or Z – in Figure 2 could electrons travelling faster than  $v_0$  arrive? 1 mark

- ii. Explain your answer to part c.i. 2 marks

---



---



---



---



---

**Solutions:**

3 (a)	1		$qE = qv_0B$ (1m) $v_0 = E/B$
3 (b)	2	$2.0 \times 10^6 \text{ m s}^{-1}$	$v_0 = E/B$ $= (5.0 \times 10^5)/(0.25)$ (1m) $= 2.0 \times 10^6 \text{ m s}^{-1}$ (1m)
3 (c) i	1	Z	
3 (c) ii	2		Increasing $v$ increases $F_B$ (1m) $F_E$ unchanged or $F_B$ greater than $F_E$ (1m)

**Question 2**

a) What speed must electrons in a beam going through a velocity selector have if the beam is undeflected by crossed electric and magnetic fields of strengths  $6.0 \times 10^3 \text{ V/m}$  and  $0.0030 \text{ T}$  respectively?

b) If the electric field is shut off, what would the radius of the beam become due to the unbalanced magnetic force?

**Question 3**

In a special experiment, an electron beam is passed through perpendicular electric and magnetic fields.

If the electrons have a speed of  $2.6 \times 10^4 \text{ m/s}$ , and the magnetic field is  $2.5 \times 10^{-4} \text{ T}$ ,

a) what electric field strength is needed so that the electrons are undeflected?

b) if the distance between the plates that causes electrical deflection is  $0.40 \text{ cm}$ , what voltage must be applied to the plates?

c) if the electric field is shut off, what would the radius of the beam become due to the unbalanced magnetic force?

Solutions:

Question 2. a)  $2.0 \times 10^6$  m/s b) 3.8 mm

Question 3. a) 6.5 N/C b) 0.026 V c)  $5.9 \times 10^{-4}$  m

#### Question 4

A beam of electrons are accelerated through a potential difference of 2.00 kV and enter a uniform magnetic field of 1.20 T directed perpendicular to their velocities.

(a) Determine the radius of their circular path.

(b) If the magnetic field is directed between a set of deflecting electric field (to achieve a velocity selector), how does the ratio of these path radii depend on the accelerating voltage and on the magnitude of the magnetic field?

### Question 5

Consider the mass spectrometer shown schematically in the Figure below.

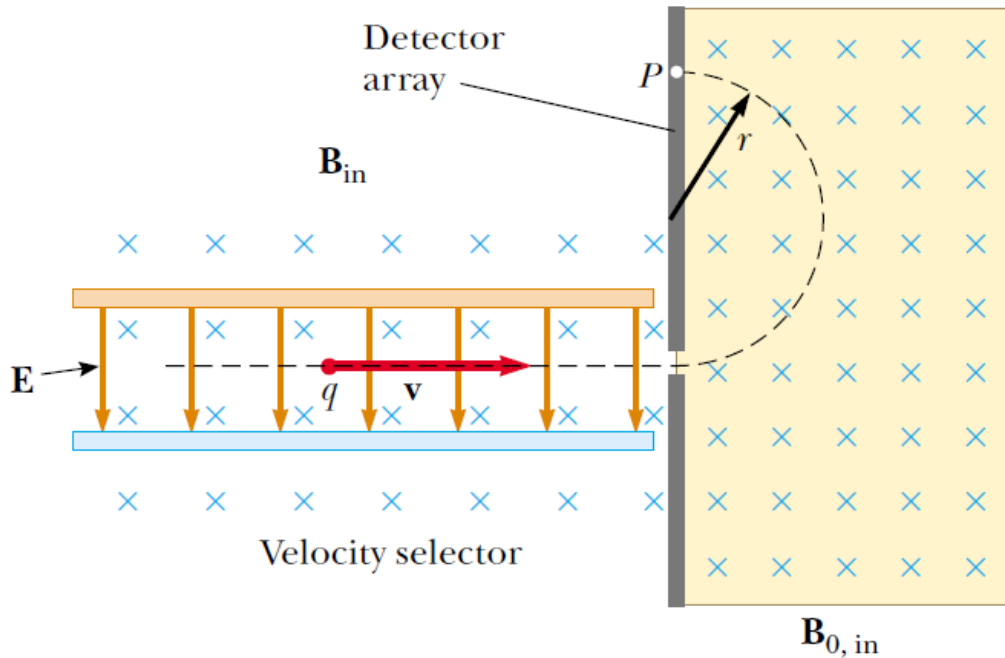

Note: A mass spectrometer separates ions according to their mass-to-charge ratio

The magnitude of the electric field between the plates of the velocity selector is 2 500 V/m, and the magnetic field in both the velocity selector and the deflection chamber has a magnitude of 0.035 0 T.

Calculate the radius of the path for a singly charged ion having a mass  $m = 2.18 \times 10^{-26}$  kg.



## The Millikan Oil-Drop Experiment

During the period from 1909 to 1913, Robert Millikan performed a brilliant set of experiments in which he measured  $e$ , the magnitude of the elementary charge on an electron, and demonstrated the quantized nature of this charge. His apparatus contains two parallel metallic plates. Oil droplets from an atomizer are allowed to pass through a small hole in the upper plate. Millikan used x-rays to ionize the air in the chamber, so that freed electrons would adhere to the oil drops, giving them a negative charge. A horizontally directed light beam is used to illuminate the oil droplets, which are viewed through a telescope whose long axis is perpendicular to the light beam. When the droplets are viewed in this manner, they appear as shining stars against a dark background, and the rate at which individual drops fall can be determined.

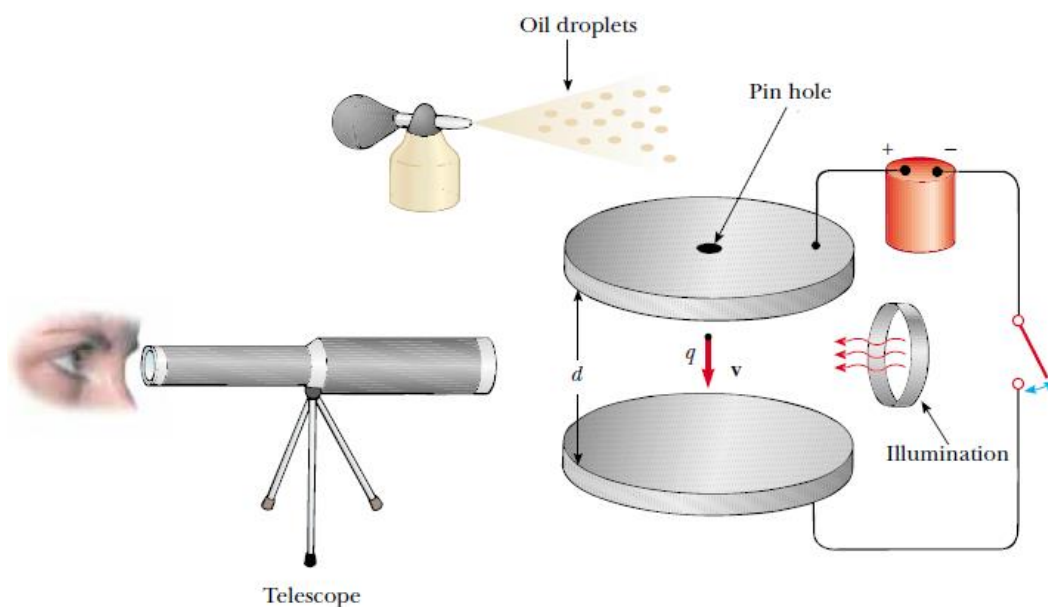

## WORKSHEET - MILLIKAN'S EXPERIMENT & RELATED PROBLEMS

- An oil drop weighs  $1.9 \times 10^{-15}$  N. It is suspended in an electric field intensity of  $6.0 \times 10^3$  N/C.
  - What is the charge on the drop?
  - How many excess electrons does it carry?
- A positively-charged oil drop weighs  $6.4 \times 10^{-13}$  N. An electric field intensity of  $4.0 \times 10^6$  N/C suspends the drop.
  - What is the charge on the drop?
  - How many electrons is the drop missing?
- If three more electrons were removed from the drop described in problem 2, what field would be needed to balance the drop?
- During a Millikan experiment, a student recorded the weight of four different oil drops. A record was also made of the intensity needed to suspend each drop.

$F_G$ (N)	$E$ (N/C)
$1.7 \times 10^{-14}$	$1.1 \times 10^5$
$5.6 \times 10^{-14}$	$3.5 \times 10^5$
$9.3 \times 10^{-14}$	$5.8 \times 10^5$
$2.9 \times 10^{-14}$	$1.8 \times 10^5$

  - Plot the readings on a graph of  $F_G$  vs  $E$  (Plot  $F_G$  on vertical axis)
  - Calculate the slope of the line. What does the slope represent?
- A drop is falling in a Millikan oil drop apparatus when the electric field is off.
  - What are the forces acting on it ?
  - If it is falling at a constant velocity, what can be said about the forces acting on it?
- What is the magnitude of the force acting on an electron in an electric field of 800 N/C?
  - A proton (mass:  $1.67 \times 10^{-27}$  kg) is suspended at rest in a uniform electric field. Take into account gravity and determine E.
- What is the electric field strength at a point in space where a proton experiences an acceleration of  $9.8 \times 10^4$  m/s<sup>2</sup>?

# Year 12 Physics SAC 2 - Semester 1 - 2018

## Multiple Choice questions

### Question 1

$$F = K \frac{Q_1 Q_2}{r^2} = 9 \times 10^9 \frac{4.0 \times 10^{-6} \times 6 \times 10^{-6}}{0.45^2} =$$

$$\text{In[5]:= } 9 * 10^9 * \frac{4.0 * 10^{-6} * 6 * 10^{-6}}{0.45^2}$$

$$\text{Out[5]= } 1.06667$$

Answer D

### Question 2

$$\frac{F_E}{F_G} = \frac{K \frac{e^2}{r^2}}{G \frac{m_e m_p}{r^2}} = \frac{K e^2}{G m_e m_p}$$

$$\text{In[6]:= } \frac{9 * 10^9 (1.6 * 10^{-19})^2}{6.67 * 10^{-11} * 9.109 * 10^{-31} * 1.672 * 10^{-27}}$$

$$\text{Out[6]= } 2.26803 \times 10^{39}$$

Answer D

Question 3

Answer D

Question 4

Answer E

Question 5

$$F_e = F_G$$

$$qE = mg$$

$$E = \frac{mg}{q}$$

$$\text{In[7]:} = \frac{6.6 * 10^{-27} * 9.8}{2 * 1.6 * 10^{-19}}$$

$$\text{Out[7]:} = 2.02125 \times 10^{-7}$$

Answer C

## Question 6

The electric force is perpendicular to the direction of motion, hence the work done is 0 J, therefore there is no change in the electric potential energy.

Answer C

## Question 7

$$E = \frac{V}{d}$$

$$\text{In[8]:} = \frac{75}{0.2}$$

$$\text{Out[8]:} = 375.$$

Answer C

## Question 8

$$\text{Work} = F_e d = qEd = qV$$

In[10]:=  $N[150 * 10^{-6} * 75]$

Out[10]= 0.01125

Answer B

## Question 9

We are looking for a false statement, which is the one about the speed of the electrically charged particle increasing in a magnetic field. Only electric fields can increase the speed of particles.

Answer B

## Question 10

Apply right hand rule.

Answer A

## Question 11

Apply right hand rule. The electron in a magnetic field has a circular trajectory (if the field is perpendicular to the velocity).

Answer C

## Question 12

Answer C

## Question 13

The car starts with zero velocity. Its gravitational potential energy gets converted to kinetic energy.

$$mgh = \frac{mv^2}{2}$$

$$gh = \frac{v^2}{2}$$

$$v = \sqrt{2gh}$$

Answer A

### Question 14

$$mg(h+H) = \frac{mv^2}{2}$$

$$v = \sqrt{2g(h+H)}$$

Answer C

## Short Answer Questions

### Question 1

Total energy = Change in gravitational potential energy between the surface of the Earth and the point where the gravity becomes 0 N/Kg + Kinetic energy at 17 km/s.

1 mark

$$\Delta E_{PG} = \text{Area under the graph} \times 1000 \times 3 \times 10^6$$

$$\text{Area} = 10.5 - 14 \text{ squares}$$



1 mark

$$\text{In}[11]= 12.2 * 1000 * 3 * 10^6$$

$$\text{Out}[11]= 3.66 \times 10^{10}$$

$$\Delta E_{PG} = 3.66 \times 10^6 \text{ J}$$

1 mark

$$E_{\text{total}} = \Delta E_{PG} + \frac{mv^2}{2}$$

$$\text{In}[12]= 3.66 * 10^6 + \frac{700 * 17000^2}{2}$$

$$\text{Out}[12]= 1.01154 \times 10^{11}$$

$$E_{\text{total}} = 1.01 \times 10^{11} \text{ J}$$

1 mark

## Question 2

The rocket is in uniform motion at zero acceleration, hence the net force on the astronaut is zero Newtons.

1 mark

$$F_{\text{NET}} = F_G - N = 0 \text{ Newtons}$$

$$N = F_G = mg = 100 \times 1.5$$

1 mark

$$N = 150 \text{ N}$$

1 mark

## Question 3

### Solution 1

$$v = \sqrt{G \frac{M_{\text{Sun}}}{R_{Q-S}}}$$

1 mark

In[14]:=  $\sqrt{6.67 * 10^{-11} * \frac{2.0 * 10^{30}}{6.5 * 10^{12}}}$

Out[14]= 4530.24

1 mark sub

$$v=4530 \text{ m/s}$$

1 mark

### Solution 2

$$g = G \frac{M_{\text{Sun}}}{R^2_{Q-S}}$$

In[15]:=  $6.67 * 10^{-11} * \frac{2.0 * 10^{30}}{(6.5 * 10^{12})^2}$

Out[15]=  $3.1574 \times 10^{-6}$

$$g = 3.1574 \times 10^{-6} \text{ N/kg}$$

1 mark

$$v = \sqrt{rg}$$

```
In[17]:=  $\sqrt{6.5 * 10^{12} * 3.157396449704142 * 10^{-6}}$ 
```

```
Out[17]= 4530.24
```

1 mark sub

$$v = 4530 \text{ m/s}$$

1 mark

## Question 4

a Ion B

1 mark

Three ions go to the left, hence they must be the negative ones.

$R = \frac{mv}{qB}$  The radius is proportional to the mass of the ions.

Ion B has the middle mass between the positive particles.

1 mark

b The magnetic field is into the page

1 mark

Apply the RHR for positive particles moving in magnetic fields.

1 mark

$$R = \frac{mv}{qB}$$

$$B = \frac{mv}{qR}$$

```
In[18]:= 
$$\frac{4 * 1.67 * 10^{-27} * 5.0 * 10^6}{1.6 * 10^{-19} * 0.50}$$

```

```
Out[18]= 0.4175
```

1 mark sub

$$B = 0.4175 \text{ T}$$

1 mark

## Question 5

a  $E_k = qV$

```
In[19]:= 
$$3.2 * 10^{-19} * 9 * 10^4$$

```

```
Out[19]= 
$$2.88 * 10^{-14}$$

```

1 mark sub

$$E_k = 2.88 \times 10^{-14} \text{ J}$$

1 mark

$$b. v = \sqrt{\frac{2E_K}{m}}$$

$$\text{In[20]:= } \sqrt{\frac{2 * 2.88 * 10^{-14}}{6.64 * 10^{-27}}}$$

$$\text{Out[20]= } 2.94528 \times 10^6$$

1 mark sub

$$v = 2.95 \times 10^6 \text{ m/s}$$

1 mark

$$c. F_{\text{Lorentz}} = qvB$$

$$\text{In[21]:= } 3.20 * 10^{-19} * 2.95 * 10^6 * 1.60 * 10^{-3}$$

$$\text{Out[21]= } 1.5104 \times 10^{-15}$$

1 mark sub

$$F_{\text{Lorentz}} = 1.51 \times 10^{-15} \text{ N}$$

1 mark

## Question 6

$$F = NBIL$$

In[22]:=  $1 * 5.0 * 10^{-5} * 1000 * 30$

Out[22]= 1.5

1 mark sub

$$F = 1.5 \text{ N}$$

1 mark

The direction of the force is up

1 mark

## Question 7

a. Anticlockwise

1 mark

b.  $F = NBIL$

In[23]:=  $500 * 0.100 * 2.0 * 0.2$

Out[23]= 20.

$$F = 20 \text{ N}$$

1 mark

Direction - up

1 mark

c.  $F=0$  N

1 mark

d. The SRC allows the coil to spin

The SRC changes the direction of the input current every half period

1 mark

This changes the direction of the forces on the coil every half period.

1 mark

Maintaining the torque in the same direction

OR

allowing the coil to spin in the same direction

1 mark

