

Student name

PHYSICS

Unit 3

Trial Examination

QUESTION AND ANSWER BOOK

Total writing time: 1 hour 30 minutes

Structure of book

	Number of Areas of study	Number of Areas of study to be answered	Number of marks
Section A – Areas of study	2	2	66
	Number of Detailed studies	Number of Detailed studies to be answered	Number of marks
Section B – Detailed studies	3	1	24
	Total		90

- Students are permitted to bring into the examination room: pens, pencils, highlighters, erasers, sharpeners, rulers, up to two pages (one A4 sheet) of pre-written notes (typed or handwritten) and one scientific calculator.
- Students are NOT permitted to bring into the examination room: blank sheets of paper and/or white out liquid/tape, mobile phones and/or any other unauthorised electronic devices.

Materials supplied

- Question and answer book of 31 pages, with a detachable data sheet in the centrefold and detachable answer sheet for multiple choice questions inside the front cover.

Instructions

- Detach the data sheet from the centre of this book, and the answer sheet for multiple choice questions, during reading time.
- Write your **name** on the top of this page and on the answer sheet for multiple choice questions.
- Unless otherwise indicated, the diagrams in this book are **not** drawn to scale.
- All written responses must be in English.

At the end of the examination

- Place the multiple choice answer sheet inside the front cover of this book.

STAV Publishing

2011

PHYSICS

Unit 3 Trial Examination

MULTIPLE CHOICE ANSWER SHEET

STUDENT NAME:	
----------------------	--

INSTRUCTIONS:	USE PENCIL ONLY
<ul style="list-style-type: none">• Write your name in the space provided above.• Use a PENCIL for ALL entries. For each question, SHADE the box which indicates your answer.• Marks will NOT be deducted for incorrect answers.• NO MARK will be given if more than ONE answer is completed for any question.• If you make a mistake, ERASE the incorrect answer – DO NOT cross it out.	

SECTION B

Show the Detailed Study answered by shading one box.

Detailed Study:

- Detailed Study 1: Einstein's special relativity
- Detailed Study 2: Materials and their use in structures
- Detailed Study 3: Further electronics

Please write the Detailed Study name in the box below to confirm your chosen Detailed Study.

Detailed Study:

	ONE ANSWER PER LINE		ONE ANSWER PER LINE
1	<input type="checkbox"/> A <input type="checkbox"/> B <input type="checkbox"/> C <input type="checkbox"/> D	7	<input type="checkbox"/> A <input type="checkbox"/> B <input type="checkbox"/> C <input type="checkbox"/> D
2	<input type="checkbox"/> A <input type="checkbox"/> B <input type="checkbox"/> C <input type="checkbox"/> D	8	<input type="checkbox"/> A <input type="checkbox"/> B <input type="checkbox"/> C <input type="checkbox"/> D
3	<input type="checkbox"/> A <input type="checkbox"/> B <input type="checkbox"/> C <input type="checkbox"/> D	9	<input type="checkbox"/> A <input type="checkbox"/> B <input type="checkbox"/> C <input type="checkbox"/> D
4	<input type="checkbox"/> A <input type="checkbox"/> B <input type="checkbox"/> C <input type="checkbox"/> D	10	<input type="checkbox"/> A <input type="checkbox"/> B <input type="checkbox"/> C <input type="checkbox"/> D
5	<input type="checkbox"/> A <input type="checkbox"/> B <input type="checkbox"/> C <input type="checkbox"/> D	11	<input type="checkbox"/> A <input type="checkbox"/> B <input type="checkbox"/> C <input type="checkbox"/> D
6	<input type="checkbox"/> A <input type="checkbox"/> B <input type="checkbox"/> C <input type="checkbox"/> D	12	<input type="checkbox"/> A <input type="checkbox"/> B <input type="checkbox"/> C <input type="checkbox"/> D

AREA OF STUDY 1 – Motion in one and two dimensions

Questions 1 to 5 relate to the following information

Steve is riding his bicycle at a constant speed of 12 m s^{-1} when he applies the brakes and comes to rest. Steve and his bicycle have a combined mass of 75 kg.

**Question 1.**

What is Steve's speed in kilometres per hour (km h^{-1}) just before he applies the brakes?

km h^{-1}

[1 mark]

Question 2.

What is Steve and his bicycle's kinetic energy prior to applying the brakes?

J

[2 marks]

Question 3.

What is the magnitude of Steve and his bicycle's momentum prior to applying the brakes?

kg m s^{-1}

[2 marks]

Steve came to rest in 15 m after applying the brakes.

Question 4.

What was the magnitude of Steve's average braking force?

N

[2 marks]

Question 5.

When Steve comes to rest both his momentum and kinetic energy are zero. Explain what has happened to both these quantities and hence determine if the situation / interaction was elastic or inelastic.

[3 marks]

Questions 6 & 7 relate to the following information

George is towing his trailer behind his car.

The mass of the car is 2500 kg and the mass of the trailer is 750 kg.



George is waiting at a set of traffic lights. When the lights turn green George accelerates forwards at a steady rate of 1.5 m s^{-2} . The frictional forces resisting the motion of the car and trailer are 50 N per 500 kg.

Question 6.

What is the magnitude of the traction force being supplied by the engine of the car?

[3 marks]

Question 7.

What is the magnitude of the tension in the coupling between the trailer and the car?

[3 marks]

Questions 8 to 10 relate to the following information

At a local cricket match Joffa hits the ball from the middle of the ground, for a distance of 120 m, across the boundary on the full for a six. The ball rose to a maximum height of 24 m above ground level. Assume the ball started its journey at ground level and travelled on a parabolic path.



Question 8.

How long was the ball in the air?

s

[2 marks]

Question 9.

At what speed did the ball leave Joffa's bat?

m s^{-1}

[3 marks]

Question 10.

At what angle to the horizontal did the ball leave Joffa's bat?

°

[2 marks]

Ancient roman catapults used twisted animal sinew to provide the 'spring' to throw missiles at their enemies.



Question 11.

If a 12 kg projectile left the catapult with a speed of 30 m s^{-1} when the sinew is stretched a distance of 100 cm, what is the best estimate of the spring constant of this catapult?

N m^{-1}

What basic assumption are you making in your calculation of this spring constant?

[3 + 2 = 5 marks]

Questions 12 & 13 relate to the following information

A student is experimenting with circular motion by twirling a 50 g weight on the end of a piece of string 50 cm long in a vertical circle.

Question 12.

What is the tension in the string at the top of the vertical circle if the speed of the weight is 4.0 m s^{-1} at that point?

N

[3 marks]

Question 13.

How fast is the weight travelling at the bottom of the circle assuming the student twirling the weight adds no further energy into the system as he twirls it?

m s^{-1}

[3 marks]

Questions 14 & 15 relate to the following information

A geostationary satellite is orbiting the Earth.

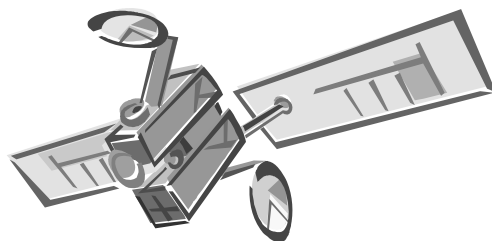

Question 14.

Show by an appropriate calculation that the radius of a geostationary orbit is approximately 42 000 kilometres.

[3 marks]

Question 15.

What is the speed of a communications satellite of mass 860 kg, in geostationary orbit?

m s^{-1}

[2 marks]

AREA OF STUDY 2 – Electronics and photonics

Questions 1 to 3 relate to the following information.

A simple circuit composed of a single fixed value resistor and a one cell battery is shown on the right. This is considered to be the **normal circuit**.

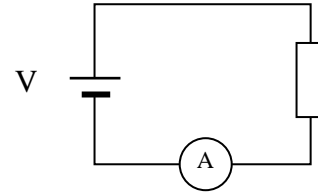

In this circuit the battery voltage is 6.0 volts and the current in the ammeter is 0.6 A.

Question 1.

The battery and resistors are the same as in the **normal circuit**. What is the current in each of the ammeters A_1 , A_2 and A_3 in the circuit on the right?

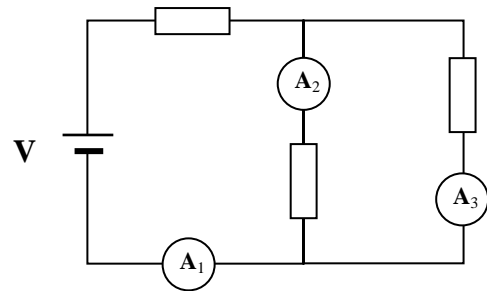

A_1		A
A_2		A
A_3		A

[3 marks]

Question 2.

The battery and resistors are the same as in the **normal circuit**. How many joules of energy are lost in the circuit on the right in 10 seconds?

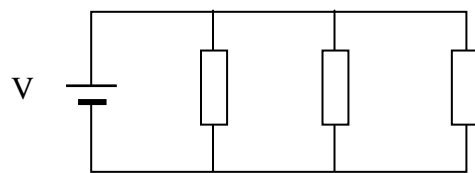

J

[3 marks]

Question 3.

What is the current in the ammeter in the following circuit?

The battery and resistor are the same as in the **normal circuit**.

Assume the diode is a standard silicon diode with a switch on voltage of 0.7 V.

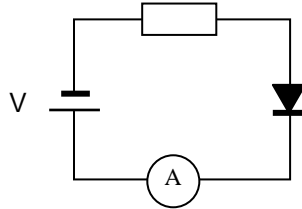

A

[2 marks]

Question 4.

What is the value of the resistor R in the following circuit?

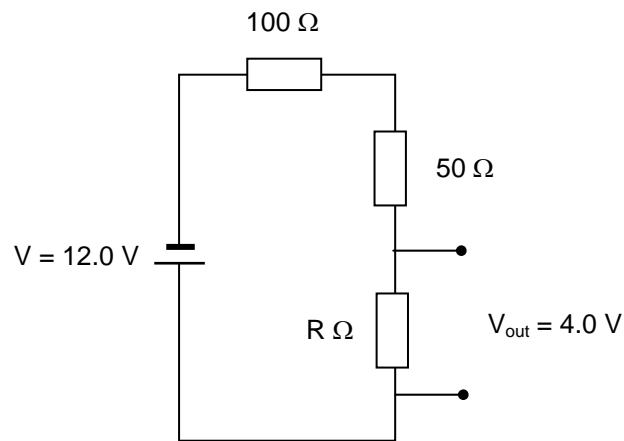

Ω

[2 marks]

Questions 5 and 6 relate to the following information.

A single stage linear **inverting** amplifier has the following attributes:

Gain = 200, Non-clipping input range = ± 50 mV

Question 5.

On the following set of axes carefully draw the amplifier characteristic for this linear amplifier.

Label the axes appropriately.

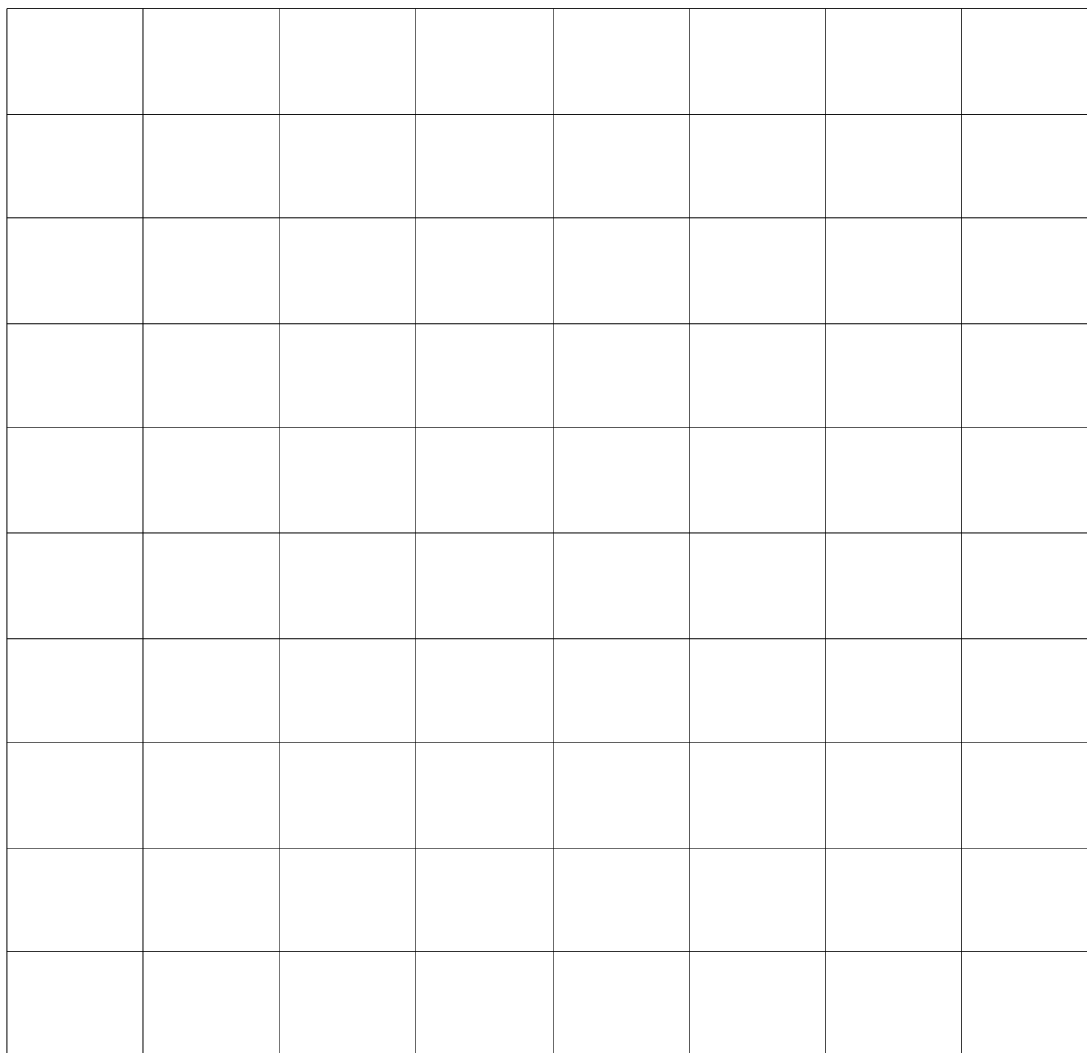

[5 marks]

Question 6.

An input signal to the single stage amplifier is shown on the first set of axes below. On the second set of axes provided, draw in the corresponding output signal. Assign a scale for the output voltage axis.

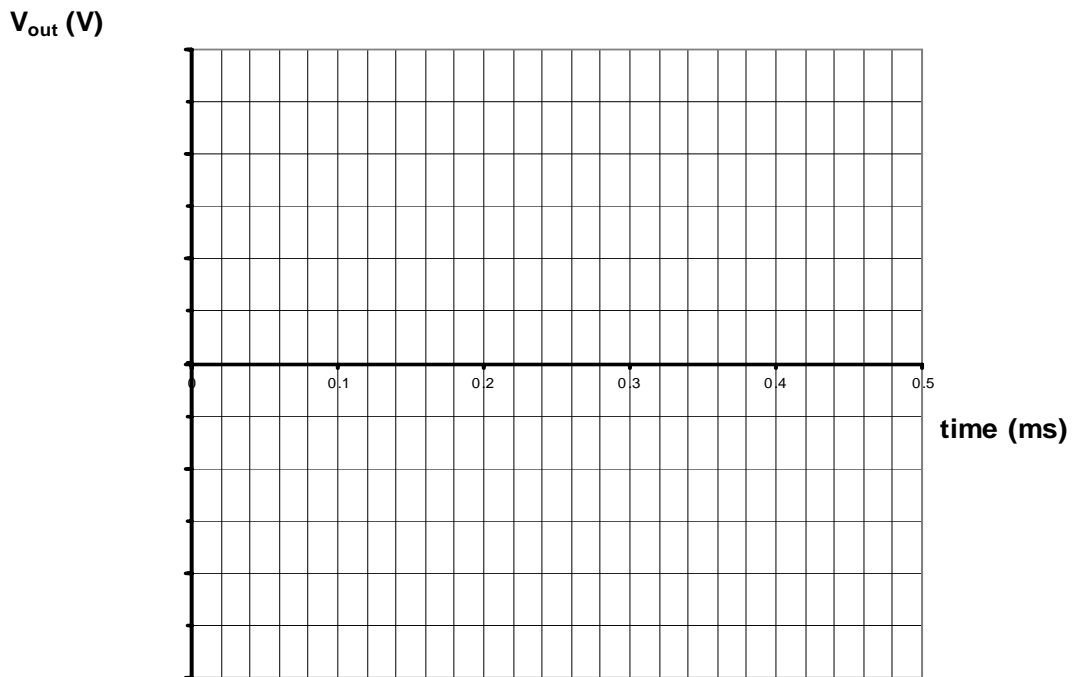
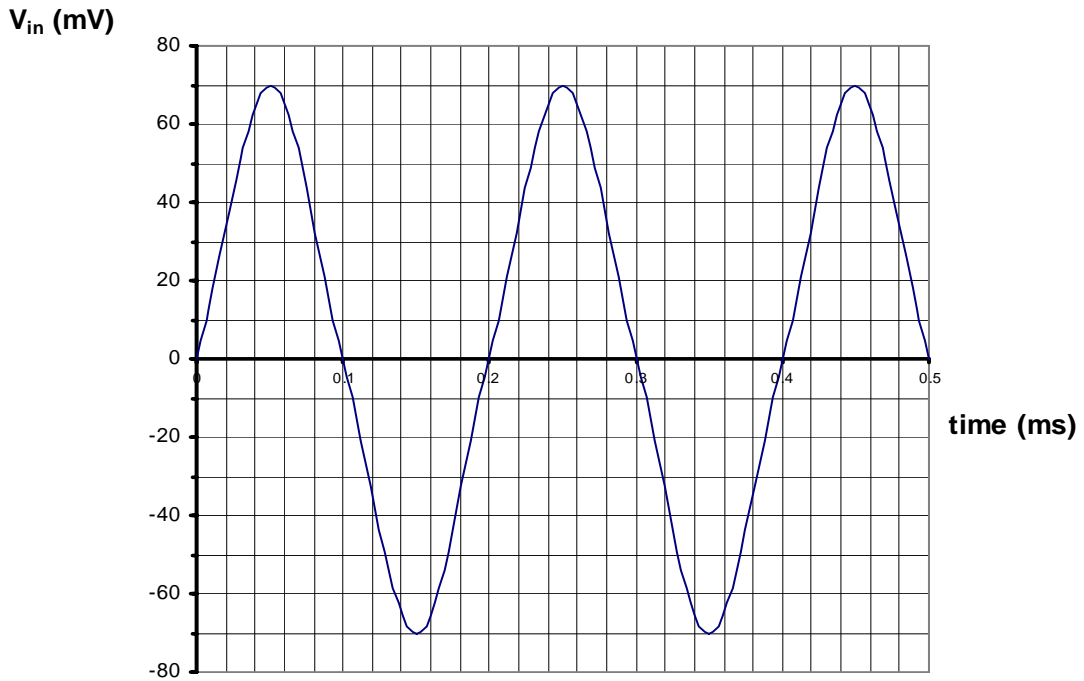

[4 marks]

Questions 7 to 9 relate to the following information.

With winter fast approaching, a young couple with a new born baby are concerned about low temperatures at night. They install a temperature dependent alarm in the nursery to warn them if the temperature is too low during the night. This alarm output can be connected to any of the points A, B or C as shown in the circuit below.

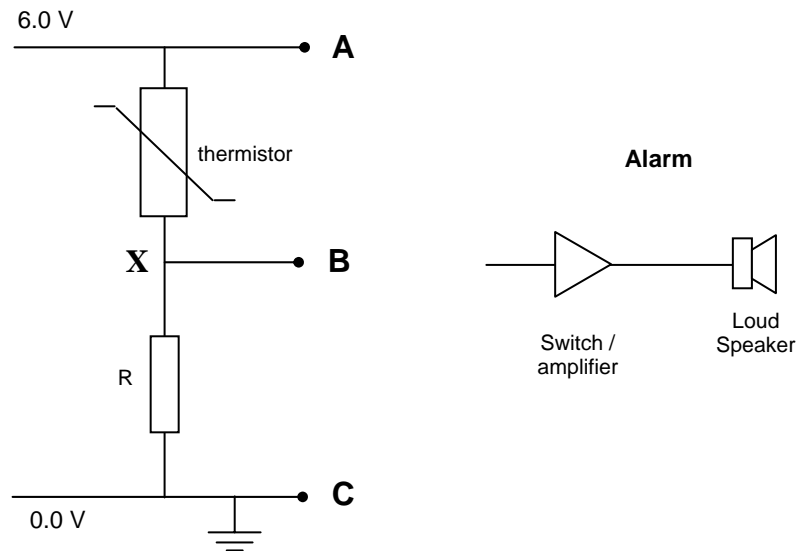

The voltage must drop below 5.0 volts for the alarm to work correctly.

A characteristic graph is shown below for the thermistor.

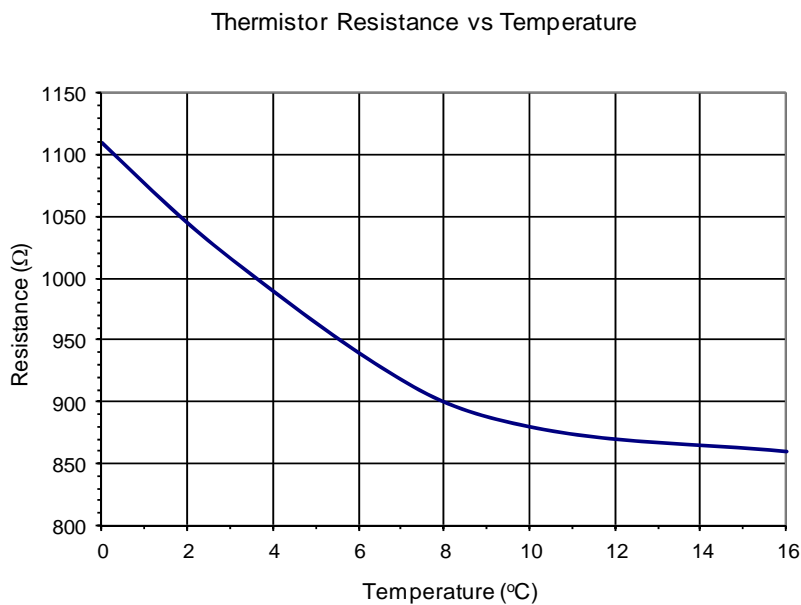

Question 7.

What is the resistance of the thermistor when the room temperature is 8°C?

Ω

[1 mark]

Question 8.

When the temperature is 8°C, what value resistor R will give a voltage of 5.0 V at point X?

Ω

[2 marks]

Question 9.

If the alarm is to go off when the temperature drops below 8°C to which of the points **A**, **B** or **C** should the alarm be attached given the Switch / amplifier turns on the siren for any voltage less than 5.0 volts?

A **B** **C** *circle your choice*

Explain your choice.

[1 + 2 = 3 marks]

Questions 10 & 11 relate to the following diagram.

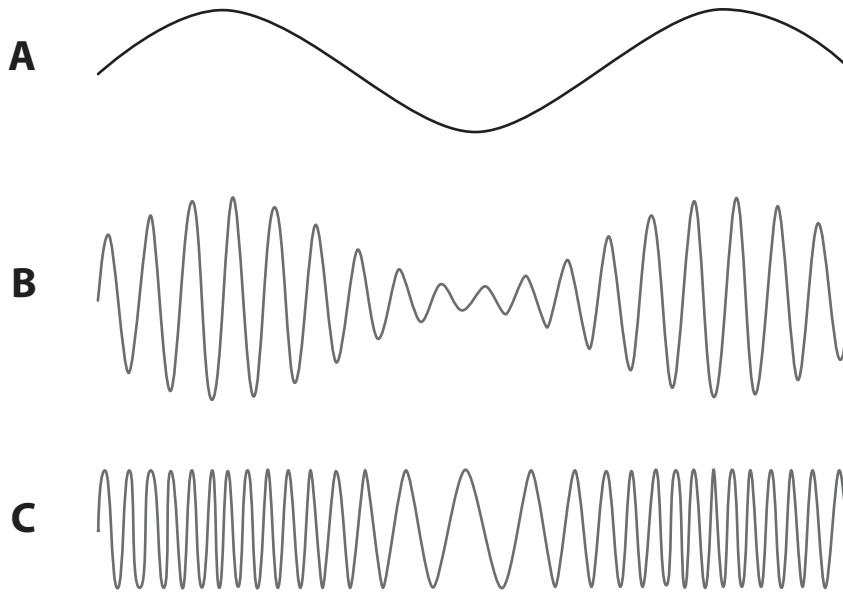

Question 10.

Which of the above three wave forms (**A, B, C**) best represents amplitude modulation of a carrier wave?

[1 mark]

Question 11.

Which of the above three wave forms (**A, B, C**) best represents a signal wave prior to modulation with a carrier wave?

[1 mark]

DETAILED STUDY 1 – Einstein’s special relativity

Questions 1 to 4 relate to the following information.

Geoff, Stuart and James are experimenting with their latest interstellar space rockets.

**Question 1.**

James is in his rocket as it travels past Geoff who is sitting at their base on the moon. As he goes past Geoff, James starts his stopwatch while Geoff does the same. As James passes an asteroid he stops his watch and notes one minute has passed. Geoff, observing all this while stationary on the moon, measures the same time interval to be 10 minutes! How fast is James travelling?

- | | |
|-----------------|----------------|
| A 0.9c | B 0.99c |
| C 0.995c | D 1.0c |

Question 2.

Stuart is travelling at 0.8c. What is the Lorentz factor for Stuart’s space craft?

- | | |
|---------------|---------------|
| A 0.80 | B 1.67 |
| C 2.24 | D 2.78 |

Question 3.

Stuart is in his spaceship and travelling at 0.8c at right angles to James who is now travelling at 0.9c. Both these speeds are measured relative to Geoff on the moon. Geoff, being a big fan of Newton, uses Pythagoras and vectors to calculate James’s speed relative to Stuart. Which of the following statements is correct in this situation?

- A** Geoff calculates that the speed of James relative to Stuart to be 1.2c.
- B** At speeds close to the speed of light Pythagoras theorem does not work as the speed of light cannot be exceeded.
- C** The speed of light in Stuart’s frame of reference is different to that in James’s and Geoff’s frame of reference.
- D** Because Stuart is travelling at right angles to James and Geoff his speed is reduced due to relativistic effects.

Question 4.

James takes on board his spaceship a brass rod of mass 1.0 kg and length 1.0 m when measured stationary on the moon's surface. Which of the following statements is true when he remeasures the rod's mass and length on the spaceship while the spaceship is travelling at $0.9c$?

- A The mass is unchanged but the length is shorter.
- B The length is unchanged but the mass is heavier.
- C The mass is heavier and the length is shorter.
- D The mass and length are both unchanged.

Question 5.

In a nuclear reaction mass is converted into energy. Approximately how much energy is released if 1.0 g of mass is converted completely into energy?

- A 10^2 J
- B 10^7 J
- C 10^{10} J
- D 10^{14} J

Question 6.

In the Large Hadron Collider (LHC) at CERN, protons, of rest mass 1.67×10^{-27} kg, are accelerated to speeds close to the speed of light. Which of the following statements is correct?

- A The protons increase in mass as they increase in speed.
- B The protons decrease in mass as they increase in speed.
- C The protons increase in mass as they decrease in speed.
- D The protons decrease in mass as they decrease in speed.

Question 7.

In another experiment a proton, of rest mass of 1.67×10^{-27} kg is accelerated to $0.995c$.

What is the relativistic mass of the proton at this speed as measured by an observer in the laboratory?

- A 1.67×10^{-29} kg
- B 1.67×10^{-28} kg
- C 1.67×10^{-25} kg
- D 1.67×10^{-26} kg

Question 8.

What is the kinetic energy of a 5000 kg satellite travelling at $0.2c$?

- A 9.00×10^{18} J B 4.59×10^{20} J
C 9.84×10^{18} J D 8.82×10^{18} J

Question 9.

Geoff, James and Stuart are travelling on a train that is travelling at high speed (some fraction of the speed of light c). Geoff is at the front of the train and Stuart is at the rear while James is seated in the middle. Geoff and Stuart take out their torches and turn them on when pointed at each other. James observes the torches to turn on simultaneously. John is standing on the station platform as the train roars by just when the torches are being turned on. Which of the following statements best describes what John sees as James passes him at the moment the torches are turned on?

- A Stuart's flashlight turns on before Geoff's.
B Geoff's flashlight turns on before Stuart's.
C Stuart's and Geoff's flashlights turn on simultaneously, because John is equidistant from Stuart and Geoff.
D Stuart's and Geoff's flashlights turn on simultaneously, because the speed of light is the same in all frames of reference according to special relativity.

Questions 10 and 11 relate to the following information.

A radioactive particle is observed in an accelerator by a stationary scientist. It is found to have a half life of 25 s when travelling at $0.9c$.

Question 10.

What is the particle's half life in its own frame of reference?

- A 10.9 s B 131.6 s
C 4.75 s D 57.4 s

DETAILED STUDY 2 – Materials and their use in structures

Questions 1 and 2 relate to the following information.

The use of the arch enabled medieval builders of castles to span wide gaps while supporting heavy loads.

One such arch found in Castle Kerak in Jordan, is shown in the picture to the right.

Two rocks that are part of the arch are marked as rock **A** and rock **B**.

Rock **A** is in the curved part of the arch and rock **B** is in the supporting column of the wall.

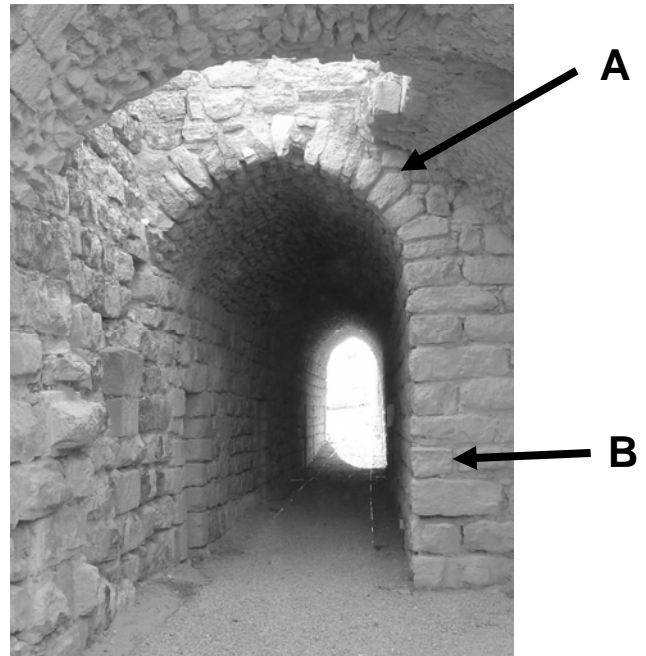
**Question 1.**

Rock A is best described as under:

- A Tension
- B Compression
- C Shear
- D Both tension and compression

Question 2.

Rock B is best described as under:

- A Tension
- B Compression
- C Shear
- D Both tension and compression

Questions 3 and 4 relate to the following information.

Typically in ancient buildings columns are made of cylindrical stone discs stacked on top of each other. An example of this is shown to the right.



A typical stress-strain graph for stone is shown below.

The points of failure are indicated by crosses (X).

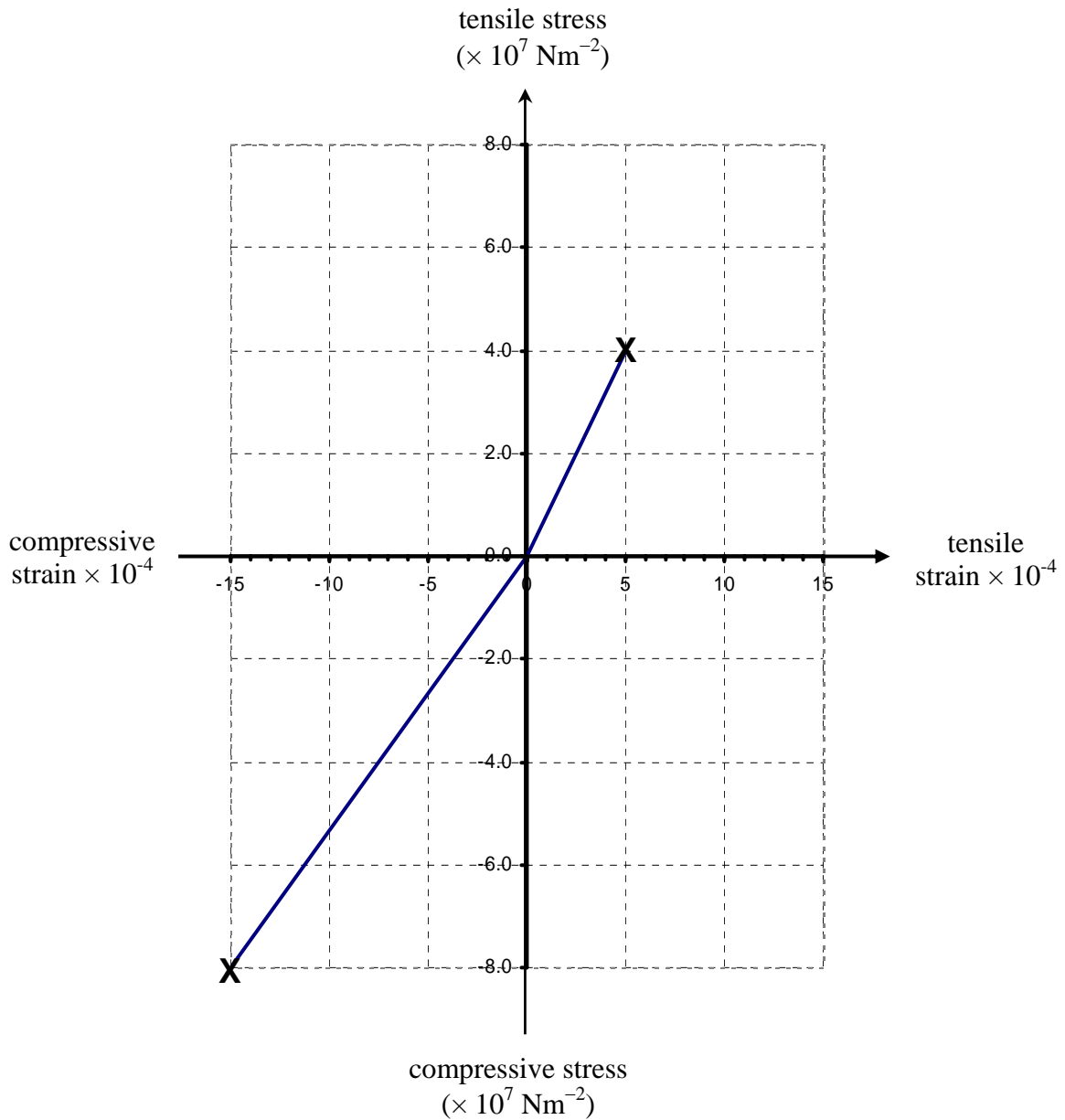

Question 3.

What is the best estimate of the value of Young's modulus for stone under tension?

- A $5.3 \times 10^{10} \text{ N m}^{-2}$ B $8.0 \times 10^{10} \text{ N m}^{-2}$
C $5.3 \times 10^3 \text{ N m}^{-2}$ D $8.0 \times 10^3 \text{ N m}^{-2}$

Question 4.

From the graph, stone can best be described as:

- A Plastic B Ductile
C Bombastic D Brittle

Questions 5 to 8 relate to the following further information.

The columns shown in the picture would have supported a stone roof in ancient times forming part of a temple building complex. The columns are 18.0 m tall from the base floor level to the fluted capital. The columns have an average cross-sectional area of 2.0 m^2 .

Question 5.

Which one of the following gives the best estimate of the largest **mass** that each column could support before fracturing?

- A $1.6 \times 10^8 \text{ N}$ B $3.0 \times 10^8 \text{ N}$
C $1.6 \times 10^7 \text{ kg}$ D $3.0 \times 10^7 \text{ kg}$

Question 6.

At the point of compressive failure, which of the following gives the best estimate of the strain energy per unit volume stored in the column?

- A $6.0 \times 10^4 \text{ J m}^{-3}$ B $1.2 \times 10^5 \text{ J m}^{-3}$
C $6.0 \times 10^8 \text{ J m}^{-3}$ D $1.2 \times 10^9 \text{ J m}^{-3}$

Question 7.

At the point of compressive failure, which of the following gives the best estimate of the actual strain energy stored in the column?

A $2.16 \times 10^6 \text{ J}$

B $4.32 \times 10^6 \text{ J}$

C $2.16 \times 10^{10} \text{ J}$

D $4.32 \times 10^{10} \text{ J}$

Question 8.

With a mass of 10 tonne (10 000 kg) placed on top of one of the columns, what is the best estimate of the change in length of the column?

A 1.7 cm

B 1.7 mm

C 0.17 mm

D $1.7 \times 10^{-5} \text{ m}$

Questions 9 and 10 relate to the following information.

The following graph shows the stress - strain relationship for four different materials (**A - D**).

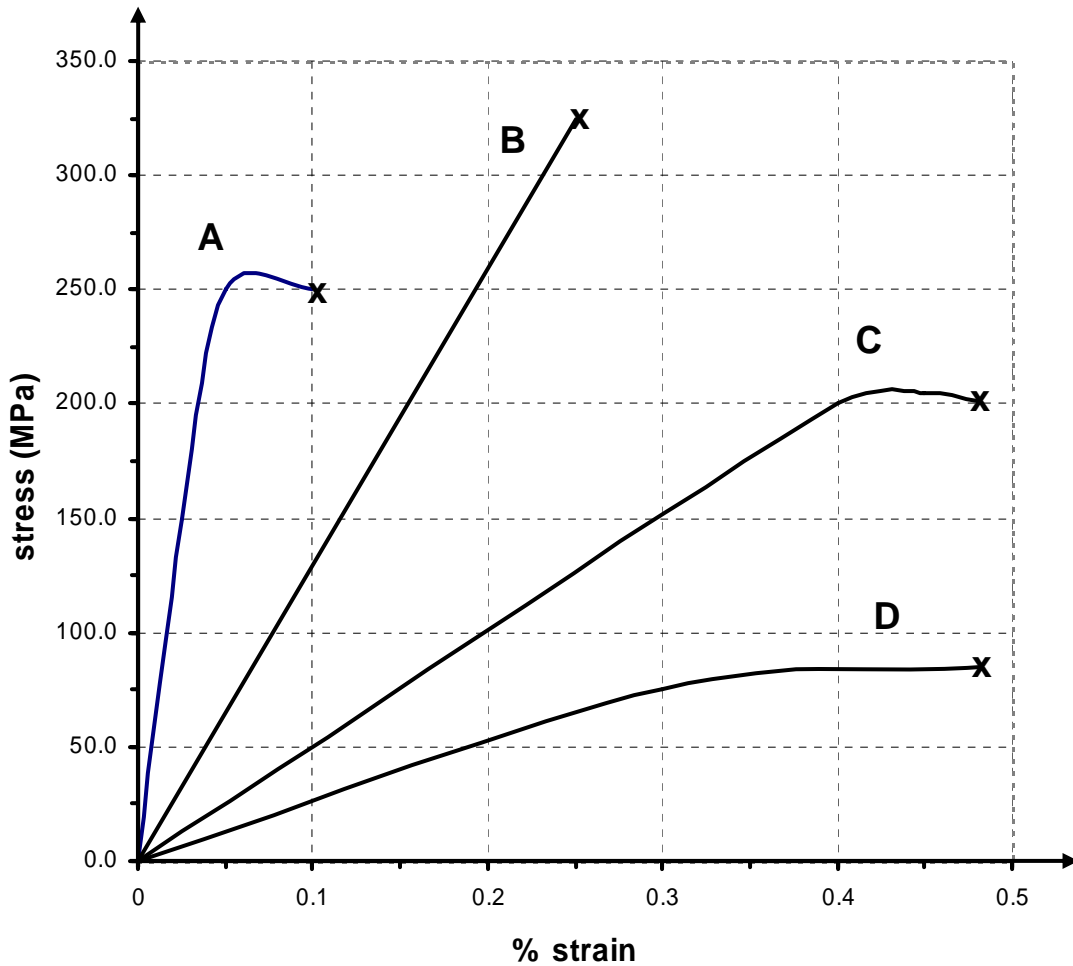

Question 9.

Which of the graphs (**A - D**) indicates the strongest material?

Question 10.

Which of the graphs (**A - D**) indicates the toughest material?

Questions 11 and 12 relate to the following information.

A lampshade of mass 2.0 kg is hung from a ceiling point by an electrical cable but it is pulled to one side by a rope connected to a side wall. This is shown in the following diagram.

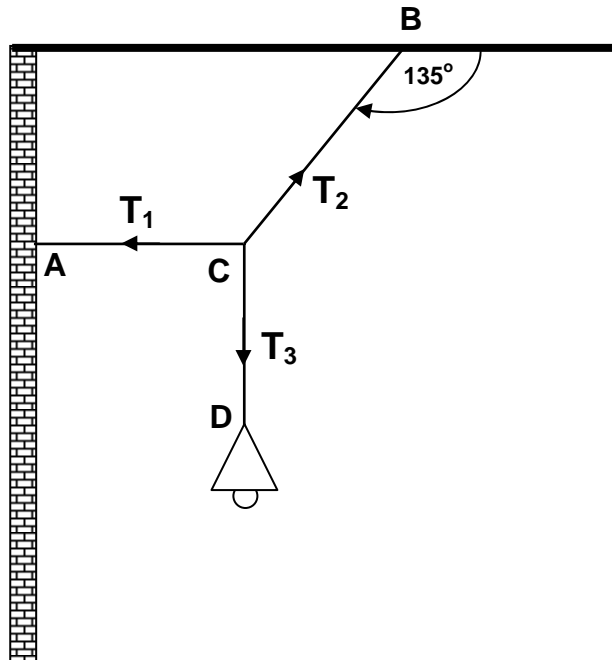

Question 11.

Which of the following is the best estimate of the magnitude of the tension labelled T_3 in the diagram?

- | | | | |
|----------|-------|----------|--------|
| A | 2.0 N | B | 14.1 N |
| C | 20 N | D | 28.3 N |

Question 12.

Which of the components **AC**, **CB** or **CD**, supporting the light fitting, could be replaced by a fixed length rod?

- | | | | |
|----------|-----------|----------|---------------------------------------|
| A | AC | B | CB |
| C | CD | D | All could be replaced by a rod |

END OF DETAILED STUDY 2

DETAILED STUDY 3 – Further electronics

Questions 1 to 9 relate to the following information.

A regulated DC power supply circuit is shown below. The AC power supply has as its input a normal household supply of 240 V RMS. The six (6) components (sub-circuits) of the regulated power supply are shown below as **U**, **V**, **W**, **X**, **Y** and **Z**.

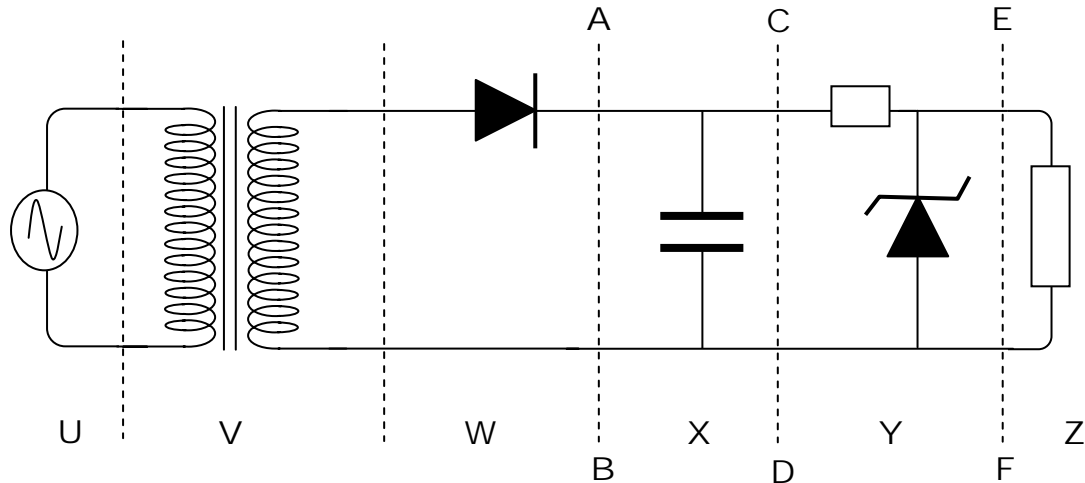

Question 1.

Component **W** is which of the following devices?

- | | |
|----------------------|----------------------------|
| A AC supply | B Smoothing circuit |
| C Transformer | D Rectifier circuit |

Question 2.

Component **Y** is which of the following devices?

- | | |
|--------------------------|----------------------------|
| A Diode rectifier | B Load |
| C Transformer | D Voltage regulator |

Question 3.

Component **Z** is which of the following devices?

- | | |
|--------------------|----------------------------|
| A Load | B Smoothing circuit |
| C AC Output | D Rectifier circuit |

Questions 4 to 6 relate to the following further information.

The transformer has a ratio of primary coils to secondary coils of **24 : 1**.

Question 4.

The RMS output voltage of the transformer going into the next stage of the circuit is:

- | | |
|-------------------------|-------------------------|
| A 10 V | B 12 V |
| C $10\sqrt{2}$ V | D $12\sqrt{2}$ V |

Question 5.

The RMS current flowing in the primary side of the transformer is 20 mA. What is the maximum possible power output of the secondary side of the transformer?

- | | |
|-----------------|-----------------|
| A 4.8 W | B 12 W |
| C 1200 W | D 4800 W |

Question 6.

What RMS current flows in the secondary side of the transformer circuit?

- | | |
|----------------|-----------------|
| A 20 mA | B 480 mA |
| C 2.0 A | D 4.8 mA |

Question 7.

A cathode ray oscilloscope is placed across the points **A B** on the circuit. The best representation of the signal seen on the CRO is:

A

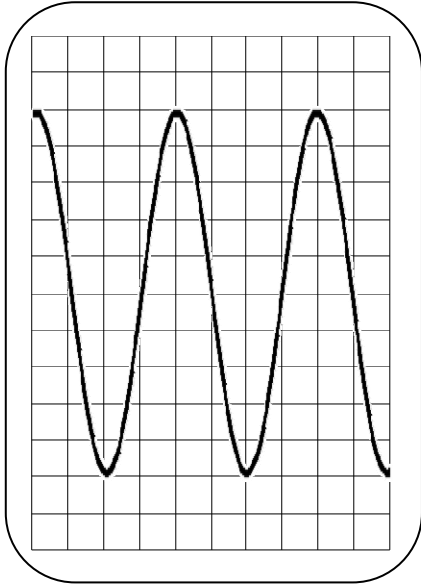

B

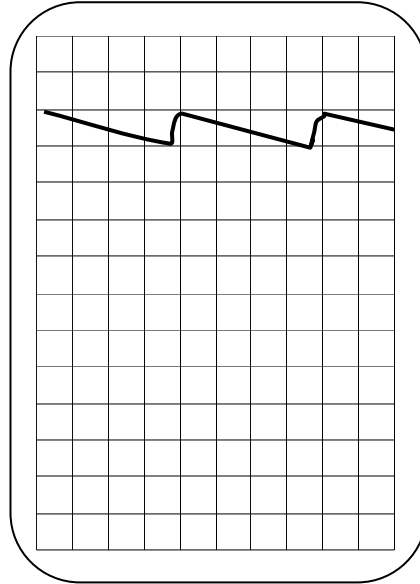

C

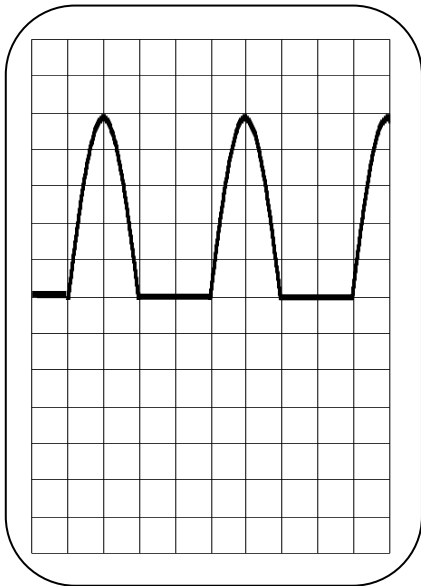

D

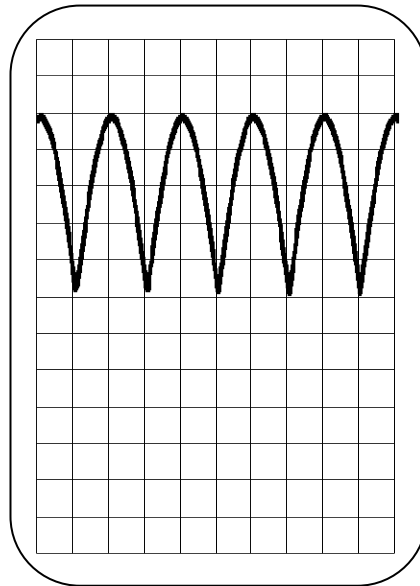

Question 8.

A cathode ray oscilloscope is placed across the points **C D** on the circuit. The best representation of the signal seen on the CRO is:

A

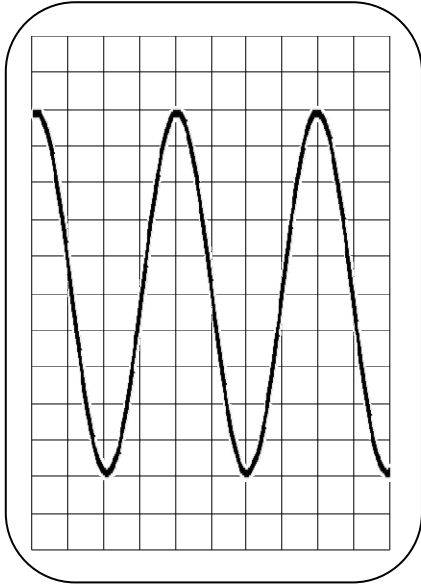

B

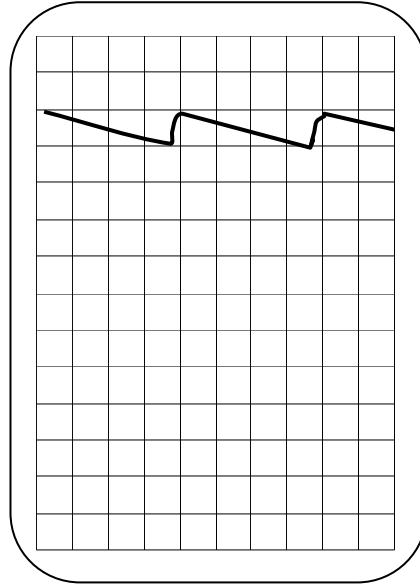

C

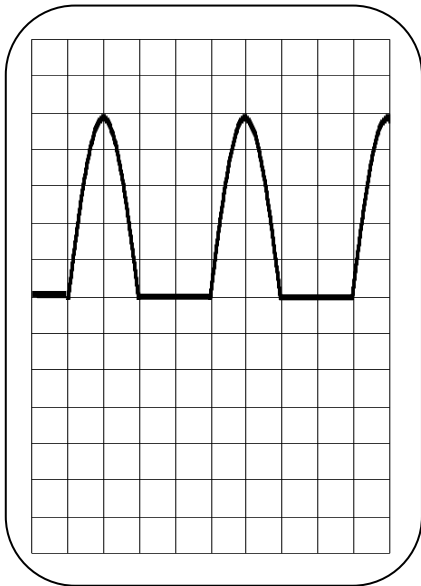

D

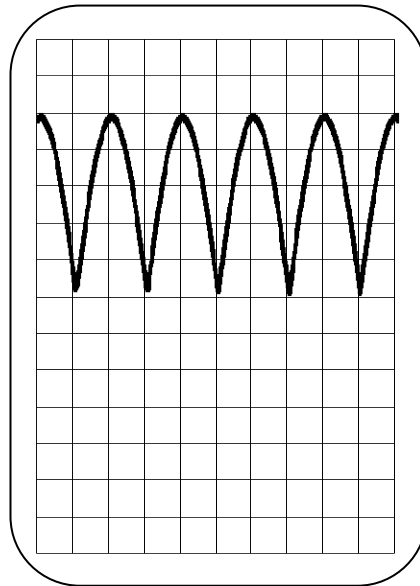

Question 9.

A cathode ray oscilloscope is placed across the points **E F** on the circuit. The best representation of the signal seen on the CRO is:

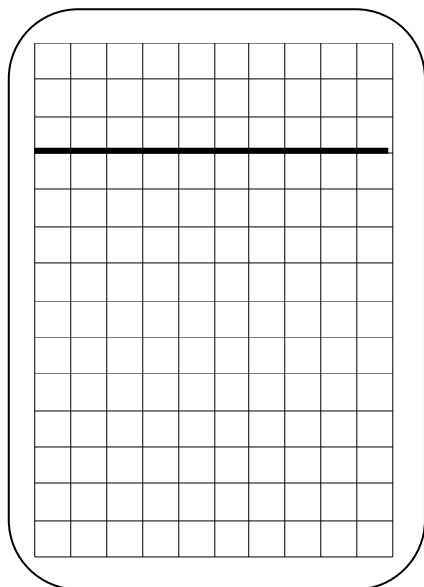
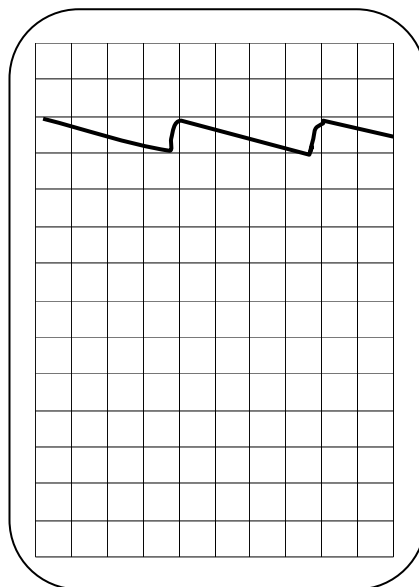
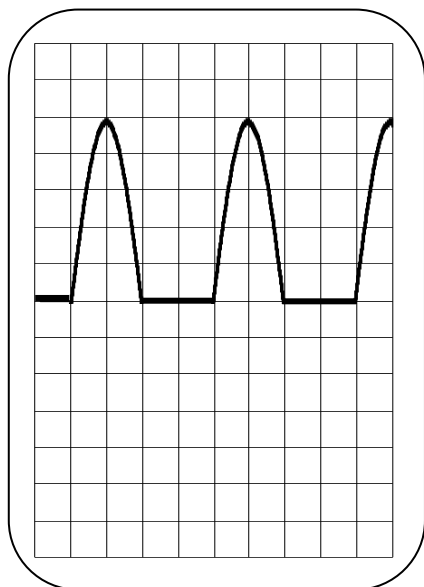
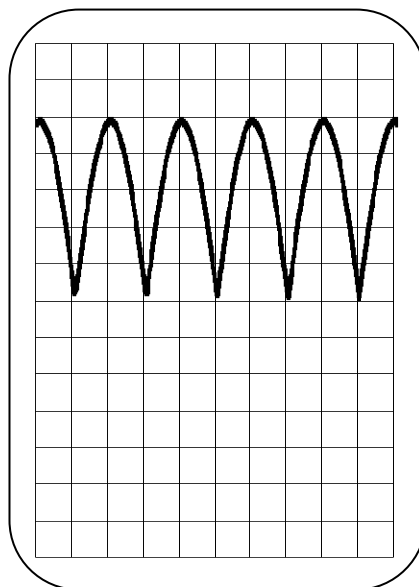
A**B****C****D**

Questions 10 and 11 relate to the following information.

Fred is working on a circuit involving a zener diode. The circuit is shown below.

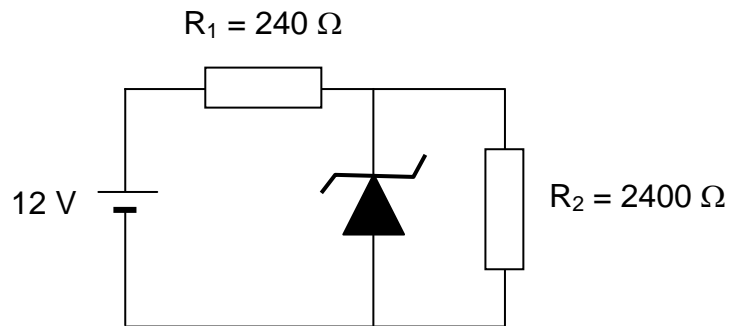

The voltage-current characteristics for the zener diode are given below.

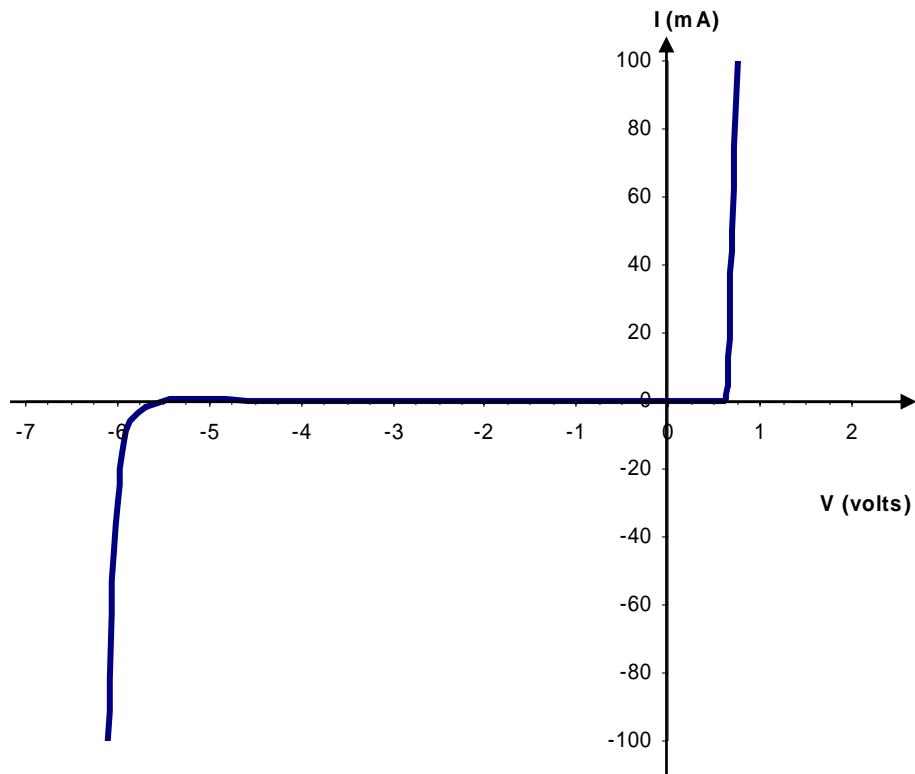

Question 10.

What is the best estimate of the current running through the resistor R_2 ?

- | | |
|---------------|-----------------|
| A 0 A | B 2.5 mA |
| C 5 mA | D 25 mA |

