



A non-profit organisation supporting students to achieve their best.

Unit 3 Chemistry

Practice Exam Solutions

Stop!

Don't look at these solutions until you have attempted the exam.

Found a mistake?

Check the Engage Education website for updated solutions, and then email practiceexams@ee.org.au.

Section A – Multiple-choice questions

Question 1

The correct answer is A.

$$2 \times n(\text{H}_2\text{O}) = n(\text{H}) = 2 \times 8.64/18.0 = 0.96\text{mol}$$

$$n(\text{CO}_2) = n(\text{C}) = 21.12/44.0 = 0.48\text{mol}$$

$$n(\text{C}) : n(\text{H}) = 1 : 2$$

Therefore, the empirical formula is CH_2

Question 2

The correct answer is C.

$$m(\text{H}_2\text{O}) = 1.124\text{g} - 0.719 = 0.405\text{g}$$

$$n(\text{H}_2\text{O}) = 0.405/18.0 = 2.25 \times 10^{-2} \text{ mol}$$

$$n(\text{CuSO}_4) = 0.719/159.7 = 4.50 \times 10^{-3} \text{ mol}$$

$$n(\text{CuSO}_4) : n(\text{H}_2\text{O}) = 1 : 5$$

Therefore, $x = 5$

Question 3

The correct answer is D.

It is the only equation in which there is a change in oxidation number. The oxidation number of Mg increases from 0 to +2 and the oxidation number of H decreases from +1 to 0.

Question 4

The correct answer is C.

The conjugate base of H_2SO_4 is HSO_4^- .

Question 5

The correct answer is D.

$$n(\text{OH}^-) = 2 \times n(\text{Ba}(\text{OH})_2) = 2 \times 0.025 \times 0.1 = 5.00 \times 10^{-3} \text{ mol}$$

$$n(\text{H}^+) = n(\text{HCl}) = 0.025 \times 0.1 = 2.50 \times 10^{-3} \text{ mol}$$

$$\text{Therefore, the amount of excess OH}^- \text{ ions} = 5.00 \times 10^{-3} \text{ mol} - 2.50 \times 10^{-3} \text{ mol} = 2.50 \times 10^{-3} \text{ mol}$$

$$[\text{OH}^-] \text{ in excess} = 2.50 \times 10^{-3}/0.050 = 0.050\text{M}$$

$$\text{pH} = 14 + \log_{10}(0.050) = 12.70$$

Question 6

The correct answer is A. This is assumed knowledge.

Question 7

The correct answer is C.

$$n(\text{Y}) = (5.22 \times 101.3)/(318 \times 8.31) = 0.20\text{mol}$$

$$n(X) : n(Y) = 3 : 1$$

Question 8

The correct answer is D.

The longest carbon chain is five, so it cannot be A or B. Option C has a higher sum of numbers than Option D, so it cannot be C.

Question 9

The correct answer is C. This is assumed knowledge.

Question 10

The answer is C.

An absorbance reading of 1.8 indicates a concentration of 0.18mg/dL in the diluted sample.

The undiluted sample has concentration $0.18 \times 1000/20 = 9.0\text{mg/dL}$.

Question 11

The correct answer is B.

This is a reaction between a weak base and a strong acid. The pH of the endpoint is thus well below 7. Using the data book, a suitable indicator can be found.

Question 12

The correct answer is A.

The polymer chain can be divided as below:

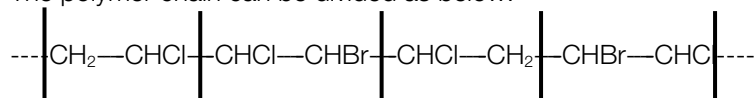

The monomers can then be identified.

Question 13

The correct answer is C.

Chlorine exists as ^{35}Cl and ^{37}Cl . The combination of these isotopes that can be found in the molecular ion (parent ion) of 1,2,3 – trichloropropane are:

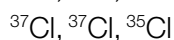
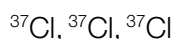
**Question 14**

The correct answer is A.

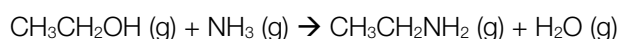
**Question 15**

The correct answer is C. This is assumed knowledge.

Question 16

The correct answer is D.

Glycosidic linkages are present in polysaccharides, therefore it cannot be A or B. An ester linkage is not present in fatty acids, therefore it cannot be C.

Question 17

The correct answer is A.

In the production of biodiesel (esters), fatty acids are reacted with methanol.

Question 18

The correct answer is B.

Fatty acids that are saturated will not go addition reactions with hydrogen. Saturated fatty acids have the general formula $C_nH_{2n}O_2$. Palmitic acid is the only fatty acid listed with a molecular formula that corresponds to this general formula.

Question 19

The correct answer is B.

The nitrogenous base A pairs with the nitrogenous base T. The nitrogenous base G pairs with the nitrogenous base C.

Question 20

The correct answer is D.

All three factors can cause denaturation.

Section B – Short-answer questions

Marks allocated are indicated by a number in square brackets, for example, [1] indicates that the line is worth one mark.

Question 1a

- $n(H) = 2 \times n(H_2O) = 2 \times 5.710/18.0 = 0.634\text{mol}$; $n(CO_2) = n(C) = 10.47/44.0 = 0.238\text{mol}$ [1]
- $m(H) = 0.634\text{g}$; $m(C) = 0.238 \times 12.0 = 2.855\text{g}$ [1] (don't round too early)
- $m(O) = m(X) - m(H) - m(C) = 1.269\text{g}$; $n(O) = 1.269/16.0 = 0.0793\text{mol}$ [1]
- $n(C) : n(H) : n(O) = 3 : 8 : 1$. Therefore, empirical formula is C_3H_8O . [1]

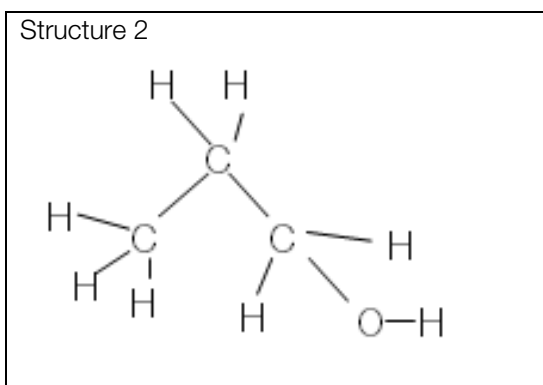
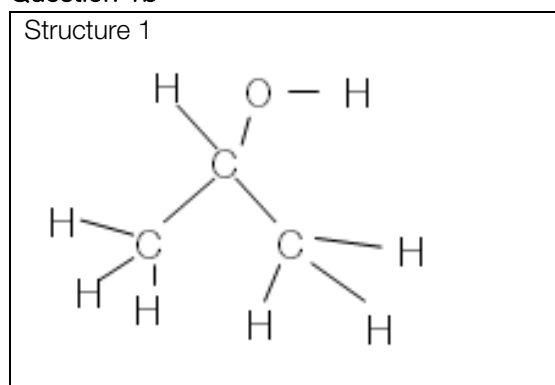
Question 1b

[1 mark for each correct structure]

Question 1c

- Only primary alkanols can be oxidised to form carboxylic acids. Therefore, X is propan-1-ol. [1]

Question 1d

- $C_4H_8(g) + Cl_2(g) \rightarrow C_4H_8Cl_2(g)$ (states are not required) [1]
- It is an addition reaction. [1]

Question 1e

- Compound Y can be either 2,2-dichlorobutane or 2,3-dichlorobutane.
- The 1H NMR spectrum has only two sets of peaks. This means that there are only two different proton environments.
- 2,2-dichlorobutane has 3 different proton environments. 2,3-dichlorobutane has 2 different proton environments.

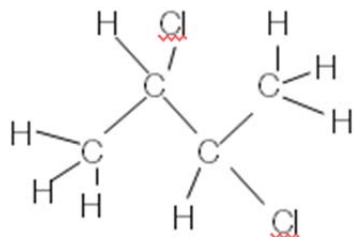

Therefore, Y is 2,3-dichlorobutane [1 mark for correct structure, 1 mark for correct name]

Question 1f, part i

The peak at 59 is caused by the fragment ion CH_3COO^+ [1]

Question 1f, part ii

The peak at 47 is caused by the fragment ion CH_3OO^+ [1]

Question 1g

Compound Z is methyl ethanoate [1]

Question 2a

C is the reductant [1]

Question 2b

- 1 mol of C reacts with 0.2 mol of $Ca_3(PO_4)_2$ and 0.6 mol of SiO_2 [1]
- Therefore, C is the limiting reagent. [1]
- $n(P_4) = 0.1 \times n(C) = 0.1 \times 1 = 0.1$ mol [1]

Question 2c

- $n(Ca_3(PO_4)_2) = 1000/310.3 = 3.223$ mol; $n(SiO_2) = 1000/64.1 = 15.6$ mol; $n(C) = 1000/12.0 = 83.3$ mol [1]
- 3.223 mol of $Ca_3(PO_4)_2$ requires 9.669 mol of SiO_2 and 16.12 mol of C. Therefore, $Ca_3(PO_4)_2$ is the limiting reagent. [1]
- $n(P_4) = 0.5 \times n(Ca_3(PO_4)_2) = 1.612$ mol; $m(P_4) = 1.612 \times 124.0 = 199.9$ g [1]
- Because process is only 90% efficient, mass of P_4 produced = $90/100 \times 199.9 = 179.9$ g

Question 3a

1100cm^{-1} : C-O [1]

1750cm^{-1} : C=O [1]

3400cm^{-1} : O-H [1]

Question 3b

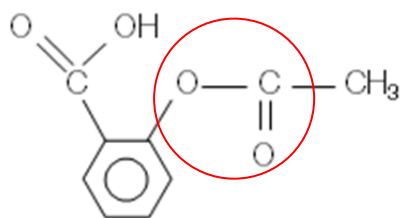

[1]

Question 3c

- $n(\text{salicylic acid}) = 26.70/138.0 = 0.1934\text{mol}$ [1]
- $n(\text{aspirin}) \text{ theoretical} = n(\text{salicylic acid}) = 0.1934\text{mol}$; $m(\text{aspirin}) \text{ theoretical} = 34.83\text{g}$ [1]
- $\% \text{ yield} = \text{actual/theoretical} \times 100 = 21.60/34.83 = 62.02\%$ [1]

Question 4a

- $(\text{NH}_4)_2\text{SO}_4 (\text{aq}) + 2\text{NaOH} (\text{aq}) \rightarrow \text{Na}_2\text{SO}_4 (\text{aq}) + 2\text{NH}_3 (\text{g}) + 2\text{H}_2\text{O} (\text{l})$ [1]

Question 4b

- $n(\text{NaOH}) \text{ excess} = 0.0400 \times 0.02436 = 9.74 \times 10^{-4} \text{ mol}$ [1]
- $n(\text{NaOH}) \text{ initial} = 0.100 \times 0.02500 = 2.50 \times 10^{-3} \text{ mol}$ [1]
- $n(\text{NaOH}) \text{ reacting} = 2.50 \times 10^{-3} - 9.74 \times 10^{-4} = 1.53 \times 10^{-3} \text{ mol}$ [1]

Question 4c

- $n((\text{NH}_4)_2\text{SO}_4) = 0.5 \times n(\text{NaOH}) = 7.63 \times 10^{-4} \text{ mol}$ [1]
- $n(\text{N}) = 2 \times n((\text{NH}_4)_2\text{SO}_4) = 1.53 \times 10^{-4} \text{ mol}$; $m(\text{N}) = 14.0 \times 1.53 \times 10^{-4} = 0.0214\text{g}$ [1]
- $\% \text{N} = 0.0214/0.600 \times 100 = 3.56\%$ [1]

Question 4d

- If the titration with HCl had slightly undershot completion, the amount of excess NaOH calculated would be **lower** [1]
- A lower amount of excess NaOH calculated would result in a **higher** calculated amount of NaOH reacting with the $(\text{NH}_4)_2\text{SO}_4$. This would **increase** the calculated amount of nitrogen in the fertiliser and hence, would lead to an **increased** calculated % of N in the fertiliser. [1]

Question 4e

Bromothymol blue or phenol red [1]

Question 4f

Conical flask	Distilled water [1]
Burette	HCl solution [1]
Pipette	NaOH solution [1]

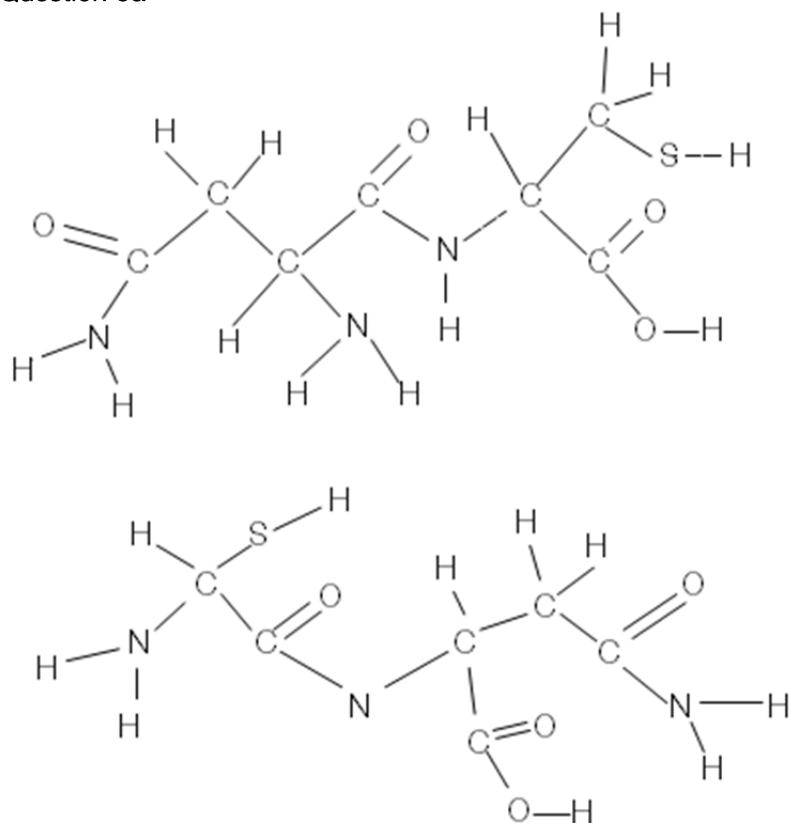
Question 5a

[1 mark for either correct structure]

Question 5b

Condensation reaction [1]

Question 5c

Water [1]

Question 5d

The primary structure of the dipeptide will remain the same. [1]

Question 5e

- Enzymes work via a 'lock and key' mechanism where a substance fits into the active site and the bonds are weakened to allow for a catalysed reaction. [1]
- If the tertiary structure is disrupted, so too is the active site in the enzyme, and the enzyme can then no longer catalyse reactions efficiently. [1]

Question 6a

Hydrogen bonding (H-bonding) [1]

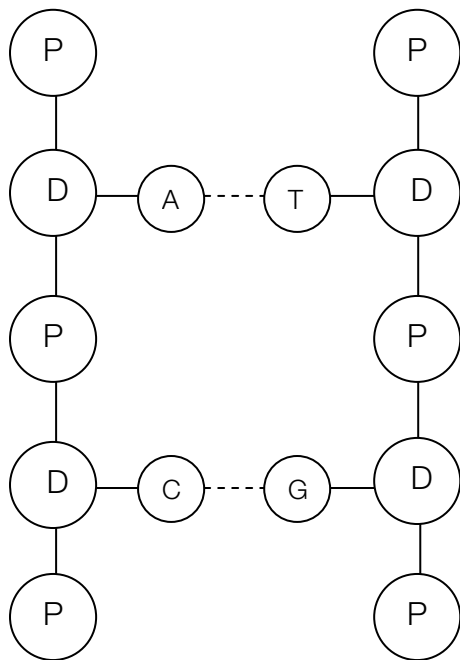
Question 6b

[1 mark for connecting deoxyribose to nitrogenous bases]

[1 mark for pairing bases correctly]

Question 6c

- The general rule to find this is $n-1$, where n represents the number of nitrogenous bases on one strand. It can be best visualised if drawn simply.
- 7 water molecules [1]

Question 7

- Applying the conservation of mass principle, the change in mass must be due to the oxygen.
- $m(\text{O}_2) = 57.4 - 45.0 = 12.4\text{g}$; $n(\text{O}_2) = 12.4/32.0 = 0.388\text{mol}$ [1]
- $2\text{Mg (s)} + \text{O}_2\text{(g)} \rightarrow 2\text{MgO (s)}$
- $n(\text{Mg}) = 2 \times n(\text{O}_2) = 0.775\text{mol}$ [1]
- $m(\text{Mg}) = 18.8\text{g}$ [1]
- mass of dish = $45.0 - 18.8 = 26.2\text{g}$ [1]

Alternatively, the mass of magnesium oxide can be found, and subtracted from the mass of the dish and magnesium oxide combined.